

KIA Stonic 09/2017 >> KIA Stonic 09/2020 >>

Partnr.: KI-132-BX

DE

• Einbauanleitung Elektrosatz Anhängervorrichtung mit 12-N Steckdose lt. DIN/ISO Norm 1724. • Wir weisen ausdrücklich darauf hin, dass eine unsachgemäße und nicht in einer Fachwerkstatt durchgeführte Montage einen Verzicht auf Entschädigung jeglicher Art insbesondere bezüglich des Produkthaftpflichtrechts zur Folge hat. • Technische Änderungen vorbehalten. • Widerstand nur gemäß der Tabelle auf dem Anhänger verwenden. • Achtung! Bitte lesen Sie vorab diese Anleitung, nehmen Sie diese zur Kenntnis und verweisen Sie Ihren Kunden auf das Bedienbuch bezgl. der eventuell zu treffenden Maßnahmen zum ziehen eines Anhängers. • Bei Funktionsproblemen ist die Fehlersuche auf ca. 0,5 Stunden zu begrenzen, kontaktieren Sie die ECS Technical Support: ts@ecs-electronics.nl / 00800 22552327

FR

• Instructions de montage du faisceau électrique pour crochet d'attelage conforme à la norme DIN/ISO 1724 prise 12-N. • Il est expressément prévu qu'il ne saurait se prévaloir d'un quelconque préjudice contractuel ou réhibitoire si le montage avait été fait en dépit des dites instructions ou dans un garage ne disposant pas des équipements adéquats. • Sous réserve de modifications techniques. • Ne excédez pas la charge maximale, indiquée dans le tableau. • Attention! Avant de commencer le branchement, on vous prie de prendre compte des connexions à faire dans la notice, ainsi que communiquer directement à votre client les mesures à prendre pour tirer une remorque. • S'il y a des problèmes de fonctionnement, limiter la recherche de défauts à env. 30 minutes et contacter ECS l'Aide en ligne: ts@ecs-electronics.nl / 00800 22 55 23 27.

NL

• Montage-handleiding elektrokabelset voor trekhaak met 12-N contactdoos vlg. DIN/ISO norm 1724. • Wij wijzen er met nadruk op, dat ondeskundige en niet door een vakkundige werkplaats uitgevoerde montage tot gevolg heeft dat daardoor ieder recht op schadevergoeding, ook op wettelijke aansprakelijkheid inzake producten, vervalt. • Technische wijzigingen voorbehouden. • Gebruik alleen belasting volgens aansluittabel op het getrokken voertuig. • Opgelet! Wij verzoeken U dringend vooraf deze instructie door te nemen, hiervan kennis te nemen en uw cliënt te verwijzen naar het instructieboekje betreffende de eventueel te nemen maatregelen voor het trekken van een aanhangwagen. • Bij werkingsproblemen moet de foutencontrole tot ca. 0,5 uur beperkt worden, neem contact op met de ECS Technical Support: ts@ecs-electronics.nl / 00800 22 55 23 27.

GB

• Fitting instructions electric wiring kit tow bar with 12-N socket up to DIN/ISO Norm 1724. • We would expressly point out that assembly not carried out properly by a competent installer will result in cancellation of any right to damage compensation, in particular those arising by virtue of the product liability act. • Contents of these kits and their fitting manuals are subject to alteration without notice, please ensure that these instructions are read and fully understood before commencing installation. • Do not overload circuits; the maximum loads per connection are detailed in this manual. • Attention! Before Installation, please read this manual carefully and inform your customer to consult the vehicle owners manual to check for any vehicle modifications required before towing. • In the event of functional problems, troubleshooting must be limited to about 0.5 hours, contact the ECS Technical Support: ts@ecs-electronics.nl / 00800 22 55 23 27.

ES

• Instrucciones de montaje de kit eléctrico para enganche de remolque con caja de conexiones 12-N según norma DIN/ISO 1724. • El montaje inapropiado y efectuado por personal no cualificado originará la pérdida de todo derecho a indemnización o la expiración de toda responsabilidad civil con respecto al producto. • Nos reservamos el derecho a efectuar modificaciones técnicas. • Utilice sólo cargas de acuerdo a la tabla de conexión del vehículo remolcado. • Atención: lea atentamente este manual antes de la instalación e informe al cliente que debe consultar el manual de usuario del vehículo para conocer cualquier modificación realizada. • En caso de tener problemas con su funcionamiento, la búsqueda de errores está limitada a aprox. 0,5 horas, por lo que le recomendamos ponerse en contacto con el servicio de atención telefónica: ts@ecs-electronics.nl / 00800 22 55 23 27.

IT

• Istruzioni di montaggio di set di cavi elettrici per gancio da traino con zoccolo a 12 N conforme alla norma DIN/ISO 1724. • Sottolineiamo espressamente che un montaggio inadeguato ed eseguito da un'officina non specializzata ha come conseguenza il decadere di qualsiasi diritto al risarcimento danni, nonché alla responsabilità legale relativa ai prodotti. • Ci si riserva il diritto di apportare modifiche tecniche. • Utilizzare esclusivamente un carico conforme alla tabella degli allacci relativa al veicolo in questione. • Attenzione! Vi invitiamo a leggere attentamente questo manuale e a invitare a vostra volta i clienti a leggere il manuale del conducente sulle eventuali misure da prendere per l'attacco di un rimorchio. • In caso di problemi di funzionamento, la ricerca di errori dovrebbe essere limitata a circa 0,5 ore. Contattare il centralino di assistenza per i fasci di cavi: ts@ecs-electronics.nl / 00800 22 55 23 27.

SE

• Monteringsanvisningar elkabelsats för dragkrok med 12-N kontaktbox enligt DIN/ISO norm 1724. • Vi påpekar med eftertryck att all rätt till skadeersättning och all laglig ansvarighet förfaller om monteringen inte har utförts på rätt sätt och av en professionell verkstad. • Tekniska ändringar förbehålles. • Änvid endast belastning enligt anslutningstabellen på det dragna fordonet. • Varning! Innan installation, läs den här handboken noga och informera din kund om att läsa fordonets användarhandbok för att undersöka vilka eventuella ändringar som behöver göras på fordonet. • Vid funtionsproblem ska felsökningen begränsas till ca 0,5 timme, kontakta reservdels-helpline ts@ecs-electronics.nl / 00800 22 55 23 27.

CZ

• Montážní pokyny: souprava pro elektrické propojení tažné tyče s 12 - N zásuvkou do normy DIN/ISO 1724. • Výslovně zdůrazňujeme, že jakákoli montáž, která není provedená ve specializované dílně, má za následek odvolání nároků na kompenzaci jakéhokoliv druhu, obzvláště vyplývajících ze zákona o odpovědnosti za způsobené škody. • Změny mohou být provedeny bez oznámení. • Použijte pouze při maximálním nabití podle tabulky na tažném vozidle. • Upozornění! Prosíme, abyste si nejdříve přečetli tyto instrukce, seznámili se s nimi a odkázali své zákazníky na příručku týkající se případných opatření, která musí být přijata pro tažení přívěsu. • Při problémech funkčnosti je třeba vyhledávání chyb omezit na cca 0,5 hodiny, kontaktujte ECS Technical Support: ts@ecs-electronics.nl / 00800 22 55 23 27.

DK

• Monteringsvejledninger for det elektriske ledningsføringssæt for trækstang med 12-N stikdåse, DIN/ISO, norm 1724. • Vi ønsker at gøre udtrykkeligt opmærksom på atforkert samling, der ikke er udført af et specialiseret værksted, resulterer i bortfaldelse af kompenseringskrav af alle slags, i særdeles krav der måtte opstå omkring det lovligtige ansvar. • Kan ændres uden varsel. • Brug kun den maksimale belastning, i overensstemmelse med forbindelsestabelen for bugserede køretøjer. • OBS! For installation skal denne vejledning læses omhyggeligt og din kunde skal informeres om at kigge i køretøjets håndbog for at kontrollere om der skal laves eventuelle ændringer på køretøjet inden bugsering. • Ved funktionsproblemer skal fejlsøgningen begrænses til ca. 0,5 time, kontakt ECS Technical Support: ts@ecs-electronics.nl / 00800 22 55 23 27.

FI

• Ohjeet vetokoukun sähkökaapelisarjan asentamiseen, jossa on DIN/ISO 1724 mukainen 12-N liitin. • Korostamme, että kaikki oikeudet vahinkokorvaukseen kuten myös valmistajan laillinen vastuu raukeavat, mikäli asennusta ei ole toteutettu oikealla tavalla eikä ammattitaitoisen asiantuntijan toimesta. • Oikeus teknisiin muutoksiin ilman erillistä huomautusta pidätetään. • Huomio! Lue tämä käyttöoppas huolellisesti ennen asennusta ja tiedota asiakkaita tarkistamaan kaikki ajoneuvon muutoksen ajoneuvon omistajan käyttöoppaas ennen hinausta. • Kuormita työvirtapiiriä ainoastaan hinattavan ajoneuvon kytkentäkaavin mukaisesti. • Virhehaku on rajoitettava toiminto-ongelmien esiintyessä noin 0,5 tuntiin, ota yhteys ECS Technical Support: ts@ecs-electronics.nl / 00800 22 55 23 27.

GR

• Οδηγίες συναρμολόγησης ηλεκτρικού σετ καλωδίων μπάρας ρυμούλκησης με υποδοχή 12-N μέτρι DIN/ISO Κανόνας 1724. • Επισημαίνουμε κατηγορηματικά ότι οποιαδήποτε ασφαλή συναρμολόγηση, η οποία δεν έχει πραγματοποιηθεί ειδικό εργαστήριο θα οδηγήσει σε αποποίηση των αξιόλογων επιβληθών αποζημιώσεων οποιαδήποτε είδους, ειδικά όσα προκύπτουν από το νόμο ευθύνης προϊόντων. • Μπορεί να τροποποιηθεί χωρίς προηγούμενη ειδοποίηση. • Χρησιμοποιείτε μόνο μέγιστο ηλεκτρικό φορτίο σύμφωνα με τον πίνακα σύνδεσης στο ρυμούλκούμενο όχημα. • Προσοχή! Πριν την εγκατάσταση, διαβάστε το εγχειρίδιο αυτό προσεκτικά και ενημερώστε τον πελάτη σας να συμβουλευτεί το εγχειρίδιο ιδιοκτητήτων οχήματος ώστε να ελέγξει τυχόν τροποποιήσεις που απαιτούνται στο όχημα πριν τη ρυμούλκηση. • Σε περίπτωση προβλημάτων λειτουργίας να περιοριστεί η αναζήτηση ασφαλών σε περί. 0,5 δευτ., επικοινωνήστε με τη γραμμή υποστήριξης ECS Technical Support: ts@ecs-electronics.nl / 00800 22 55 23 27.

NO

• Monteringsanviser elkabelsett for trekstang med 12-N koblingsboks ifølge DIN/ISO norm 1724. • Vi påpeker ettertrykkelig at all rett til skadeerstatning og rettslig ansvar forfaller dersom monteringen ikke er blitt utført på riktig måte og av et profesjonelt verksted. • Tekniske endringer forbeholdes. • Overskrid ikke grensene anviset i tilkoblingstabellen på tilhengeren eller det tilkoblede kjøretøyet. • OBS! Les denne bruksanvisningen nøye før installasjon. Be kunden om å rådføre seg med brukerhåndboken for kjøretøyeiere for å sjekke om kjøretøyet må modifiseres før tauing. • Ved funksjonsproblemer må feilsøket begrenses til ca. 0,5 timer, kontakt ECS Technical Support: ts@ecs-electronics.nl / 00800 22 55 23 27.

PL

• Instrukcje montażu zestawu okablowania elektrycznego dysza holowniczego z 12-N stykowym gniazdem DIN/ISO 1724. • Chcielibyśmy wyraźnie zaznaczyć, iż wszelki nieprawidłowy montaż, który nie jest wykonywany w specjalistycznym warsztacie posiada z sobą utratę możliwości dochodzenia wszelkiego typu roszczeń, w szczególności tych wynikających z odpowiedzialności producenta za swój produkt. • Podlega zmianom bez powiadomienia. • Używać tylko takiego maksymalnego obciążenia które wynika z tabliczki połączeń holowanego pojazdu. • Uwaga! Przed zainstalowaniem należy dokładnie przeczytać tę instrukcję i poinformować klienta o konieczności sprawdzenia w instrukcji posiadacza pojazdu w celu sprawdzenia przed holowaniem, czy nie wprowadzono do pojazdu jakichkolwiek zmian. • W przypadku problemów ograniczyć wyszukiwanie błędów do ok. 0,5 godziny, skontaktować się z linią serwisową ts@ecs-electronics.nl / 00800 22 55 23 27.

Einzelteilliste

Liste de pieces

Onderdelenlijst

Part list

Lista de componentes

Elenco componenti

Dellista

Seznam dílů

Del-liste

Osaluettelo

Κατάλογος εξαρτημάτων

Delliste

Lista części

(DE)

(FR)

(NL)

(GB)

(ES)

(IT)

(SE)

(CZ)

(DK)

(FI)

(GR)

(NO)

(PL)

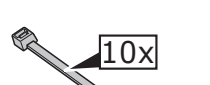
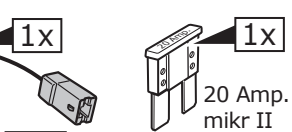
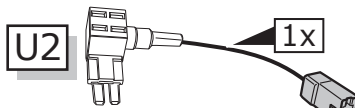
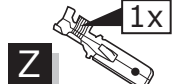
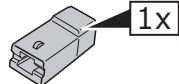
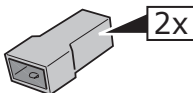
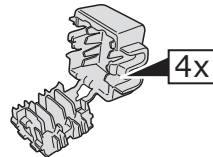
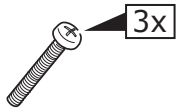
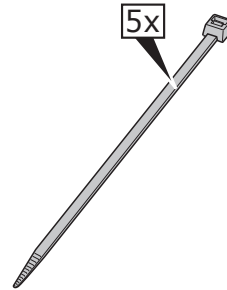
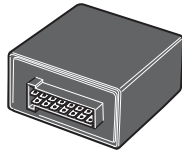
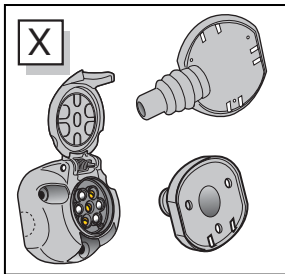
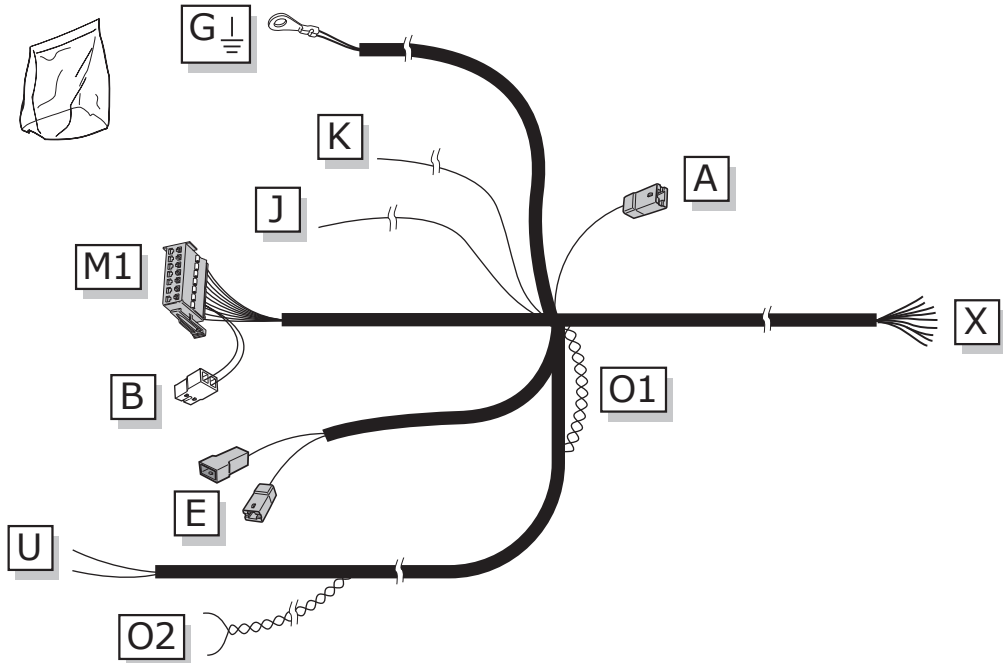
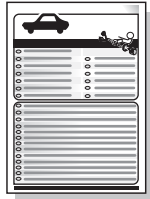
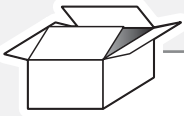

INFO

	BK	BN	BU	GY	GN	WH	YE	OG	PE	PI	RD
DE	Schwarz	Braun	Blau	Grau	Grün	Weiß	Gelb	Orange	Violett	Rosa	Rot
FR	Noir	Marron	Bleu	Gris	Vert	Blanc	Jaune	Orange	Violet	PI	Rouge
NL	Zwart	Bruin	Blauw	Grijs	Groen	Wit	Geel	Oranje	Paars	Roze	Rood
GB	Black	Brown	Blue	Grey	Green	White	Yellow	Orange	Purple	Pink	Red
ES	Negro	Marrón	Azul	Gris	Verde	Blanco	Amarillo	Naranja	Morado	Rosa	Rojo
IT	Nero	Marrone	Blui	Grigio	Verde	Bianco	Giallo	Arancione	Viola	Rosa	Rosso

ROUTING

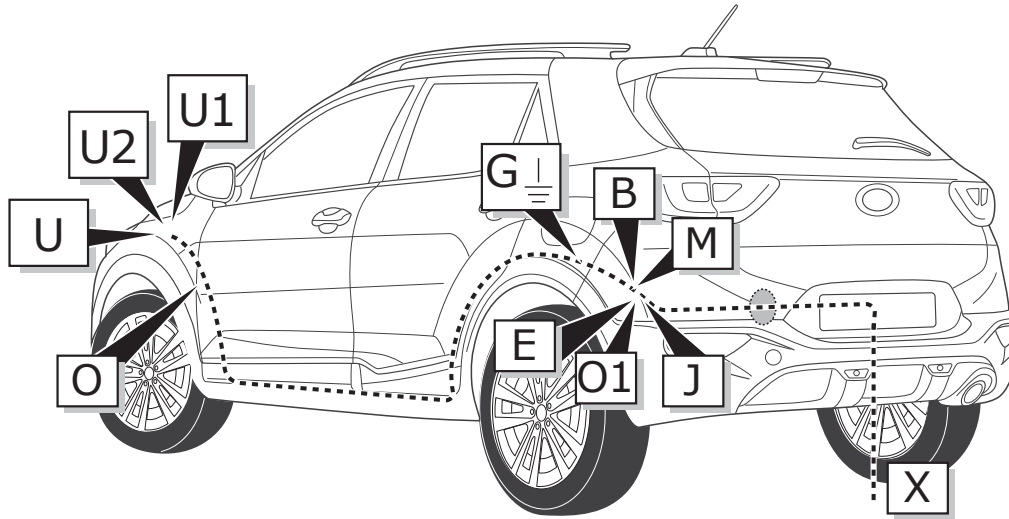

1

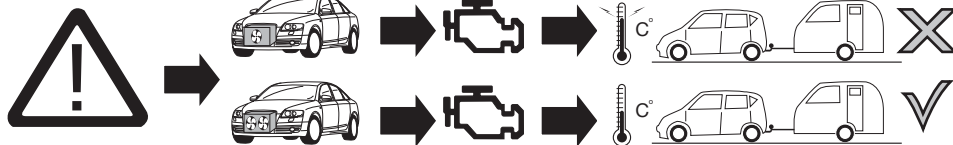

ACHTUNG!

DE

Die Kühlerleistung des Fahrzeuges muß bei Nachrüstung einer Anhängerkupplung möglicherweise erhöht werden! Bitte unbedingt Herstellerangaben beachten!!

ATTENTION!

FR

Il peut s'avérer nécessaire d'augmenter la puissance du radiateur du véhicule lorsque celui est équipé ultérieurement d'un attelage remorque! Respecter impérativement les instructions du constructeur!!

ATTENTIE!

NL

Het koelvermogen van het voertuig moet mogelijk worden verhoogd als achteraf een aanhangerkoppeling wordt aangebracht! Absoluut de fabrieksopgaven in acht nemen a.u.b.!!

ATTENTION!

GB

The vehicle's cooling capacity may have to be increased when retrofitting a trailer coupling! You must observe the manufacturer's instructions!!

¡ATENCIÓN!

ES

¡Es posible que haya que aumentar la capacidad del radiador en caso de reequipar un acoplamiento de remolque! ¡Rogamos tener en cuenta las instrucciones de fabricante sin falta!

ATTENZIONE!

IT

La capacità di raffreddamento del veicolo, quando si applica un gancio di traino, si deve possibilmente aumentare! Si prega di osservare tassativamente le indicazioni del produttore!!

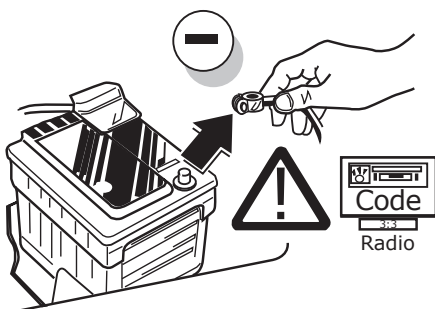

DE

Um Störungen und Schäden am Bordnetz zu vermeiden, muss die Massepolklemme unbedingt vor Beginn aller Arbeiten von der Fahrzeugbatterie getrennt werden! Insbesondere bei Arbeiten und Anschlüssen am CAN-Datenbus kann bei nicht abgeklemmter Batterie sowohl das Anhängermodul als auch das fahrzeugseitige Bordnetzsteuergerät beschädigt werden! Bitte Herstellervorschriften beim Ab- und Anklemmen der Fahrzeugbatterie beachten!

FR

Afin d'éviter tout dys-fonctionnement ou endom-magement du circuit de bord, il est indispensable de débrancher la pince de masse de la batterie du véhicule avant le début de toute opération! En particulier s'il s'agit de travaux et de branchements effectués sur le bus de données CAN, si la batterie n'est pas débranchée, le module remorque aussi bien que le dispositif de commande de circuit de bord du véhicule risquent d'être endommagés! Veuillez respecter les directives du fabricant lors du branchement et du débranchement de la batterie du véhicule!

NL

Om storingen en schade aan de elektrische bedrading te vermijden moet de massapoolklem absoluut vóór aanvang van alle werkzaamheden worden losgekoppeld van de voertuigaccu! Vooral bij werkzaamheden aan en aansluitingen op de CAN-databus kan zowel de aanhangermodule als de voertuigzijdige regeleenheid voor de elektrische installatie beschadigd worden, als de accu niet ontkoppeld is! Fabrieksvoorschriften bij het vast- en loskoppelen van de voertuigaccu in acht nemen a.u.b.!

GB

In order to avoid mal-functions and damage to the vehicle's electrical system the earth terminal must be disconnected from the vehicle's battery before starting work! Both the trailer module and the vehicle's control unit for the electrical system can be damaged during work on the CAN data bus connections if the battery is not disconnected! Please pay attention to the manufacturer's instructions when disconnecting and reconnecting the vehicle's battery!

ES

¡Para evitar fallos y defectos en el sistema eléctrico de a bordo es imprescindible separar al terminal de puesta a tierra de la batería del vehículo antes de realizar cualquier trabajo! ¡Particularmente al realizar trabajos y conexiones al bus de datos CAN puede estropearse tanto el módulo para remolques como el regulador del sistema eléctrico de a bordo del vehículo si no se ha desconectado la batería! ¡Rogamos observar las instrucciones del fabricante al conectar y desconectar la batería del vehículo!

IT

Per evitare disturbi e danni alla rete di distribuzione elettrica, l'espansione polare a massa deve essere assolutamente scollegata dalla batteria del veicolo prima dell'inizio dei lavori! In particolare durante i lavori e gli allacciamenti al bus di dati CAN, se la batteria non è scollegata si possono danneggiare sia la centralina rimorchio, sia la centralina della rete di distribuzione elettrica del veicolo! Attenersi alle indicazioni del costruttore per scollegare e ricollegare la batteria del veicolo!

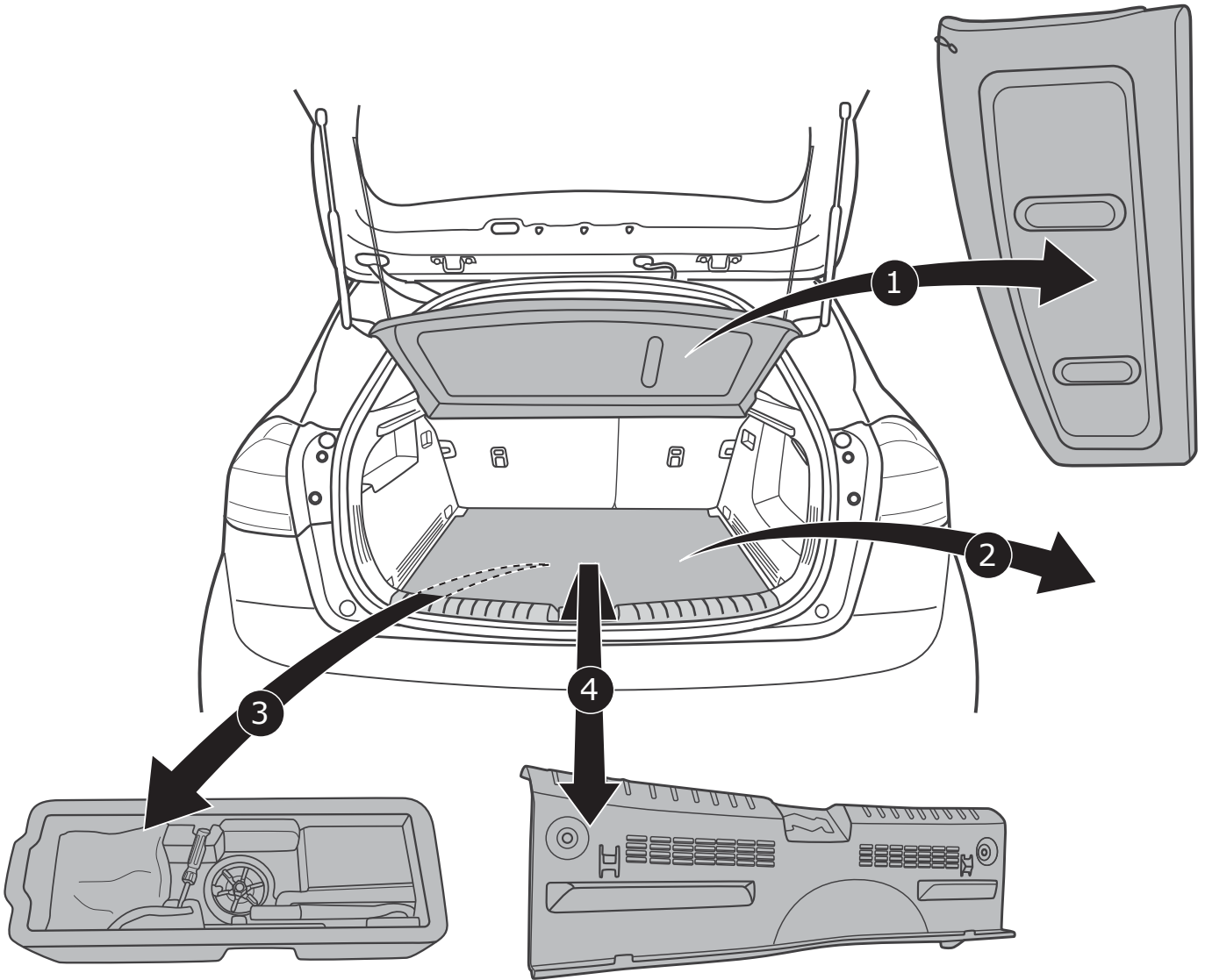
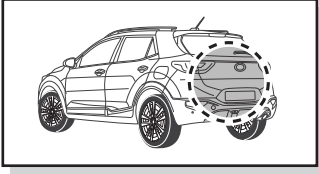

3

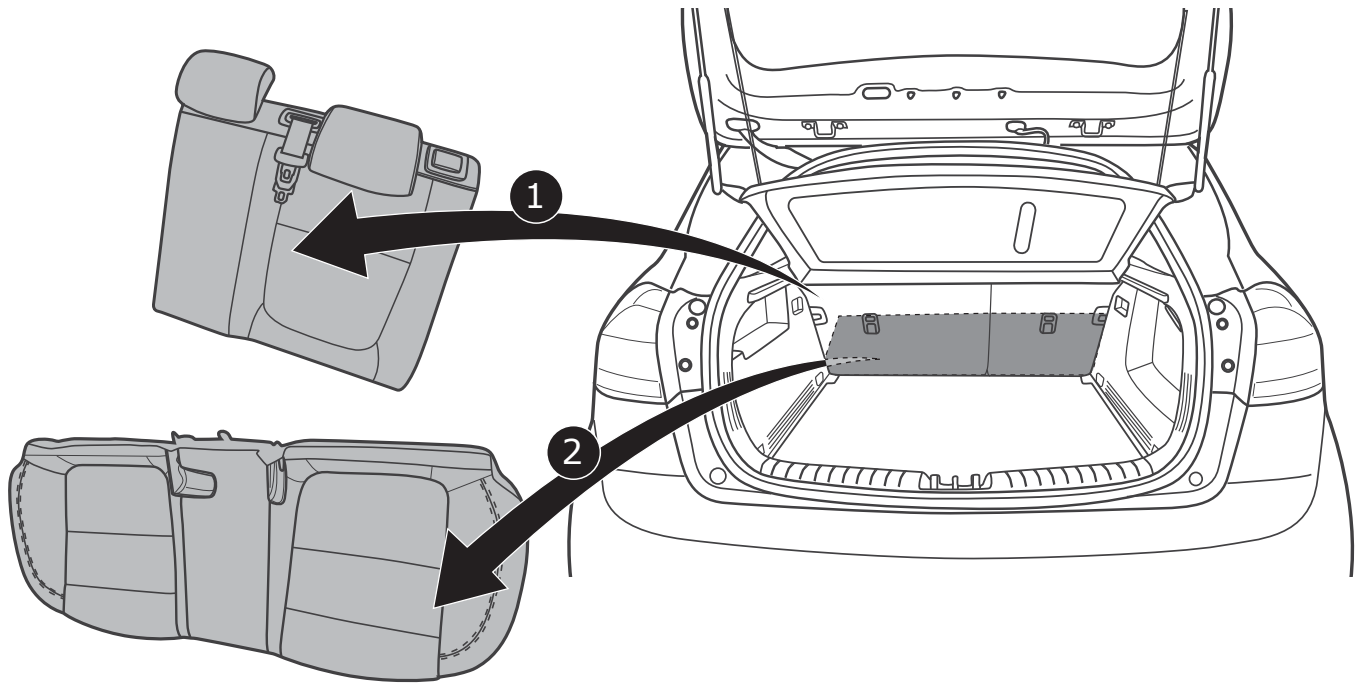
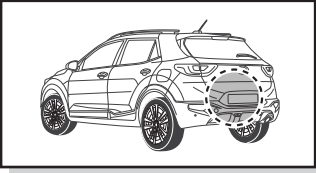

4

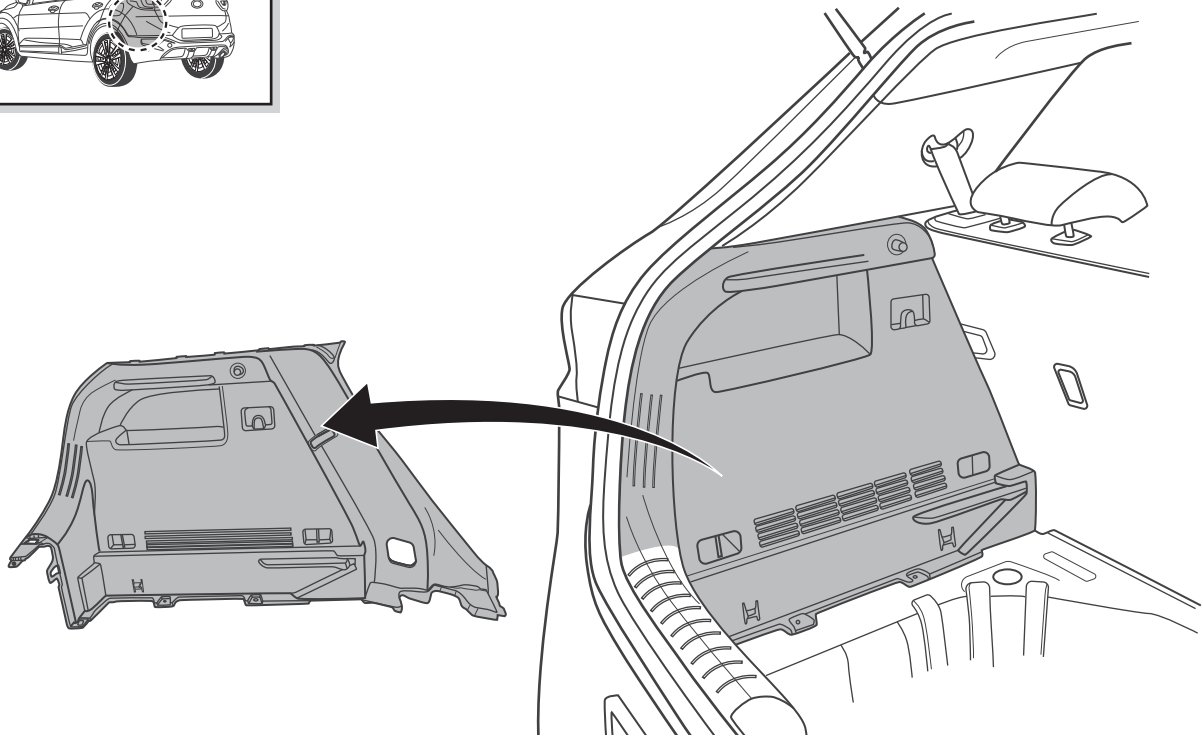
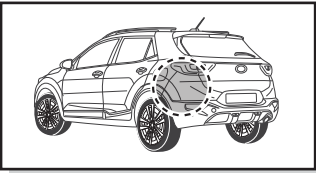

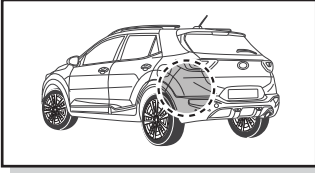

DE Klebeband entfernen.	CZ Odstraňte pásku.
FR Enlevez Ruban adhésif.	DK Aftag tapen.
NL Tape verwijderen.	FI Poista teippi.
GB Remove tape.	GR Αφαιρέστε την ταινία.
ES Retirar la cinta adhesiva.	NO Fjern limbåndet.
IT Rimuovere il nastro adesivo.	PL Zdjąć taśmę.
SE Avlägsna klisterbandet.	

1 

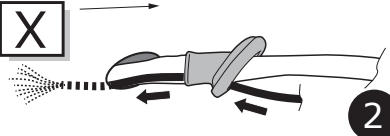
2 

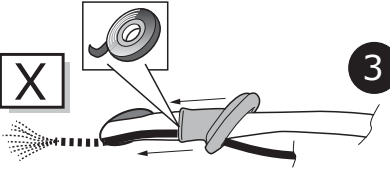
3 

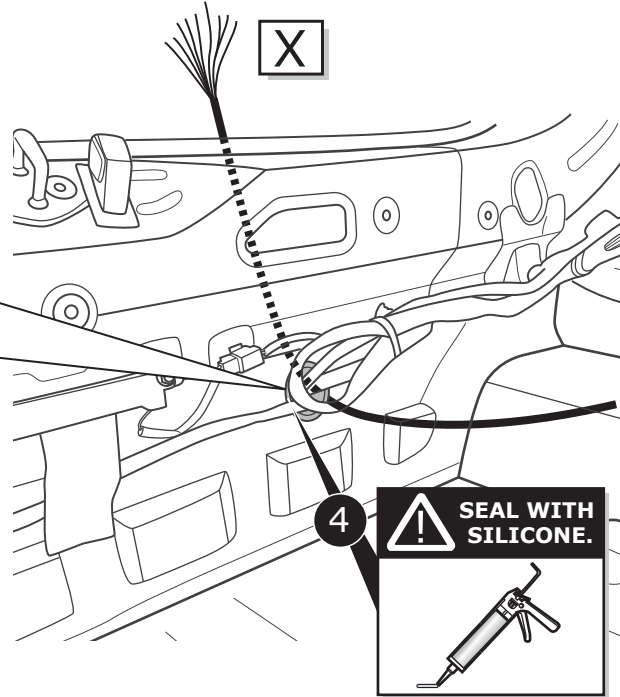
4 

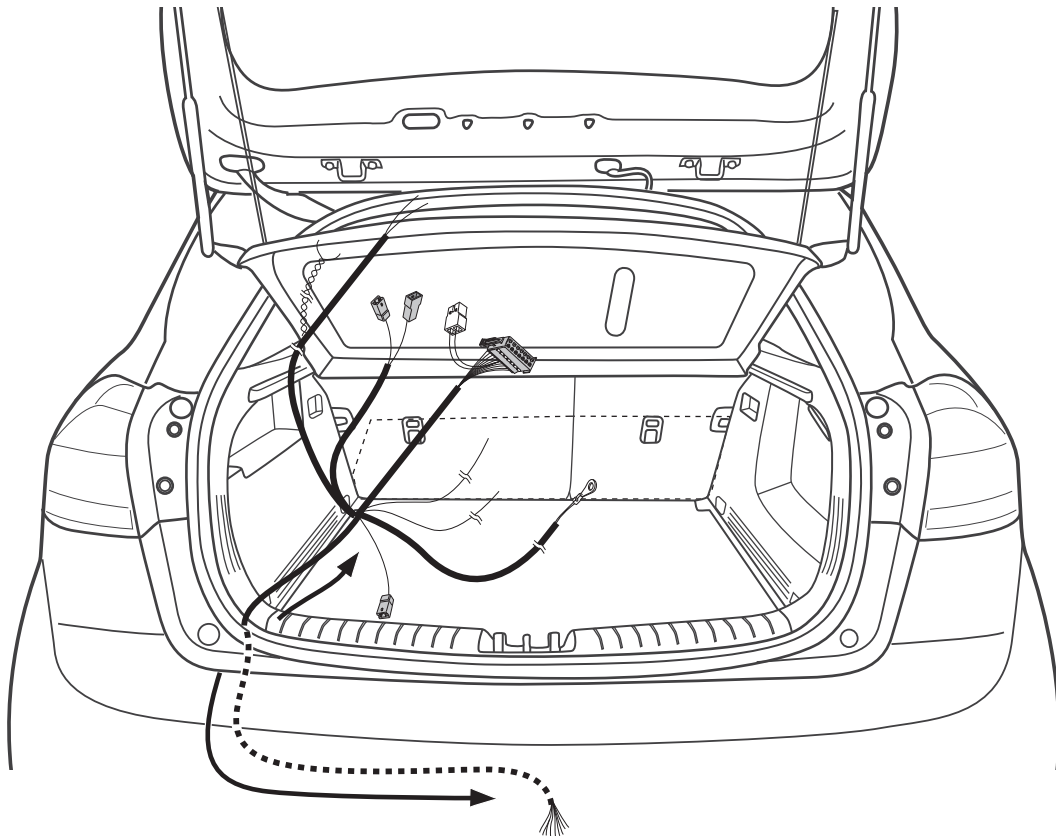

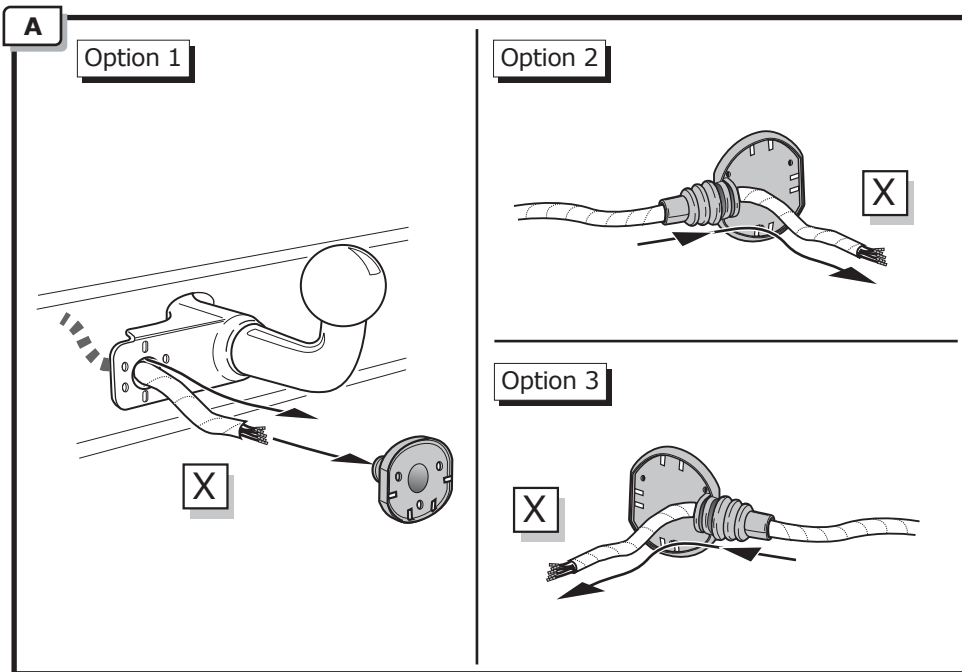

INFO

- (DE) Anschluss Steckdose
- (FR) Connection de la prise
- (NL) Contactdoos aansluiting
- (GB) Socket connection
- (ES) Conexión de la caja de enchufe
- (IT) Allaccio zoccolo

 **Page 21**

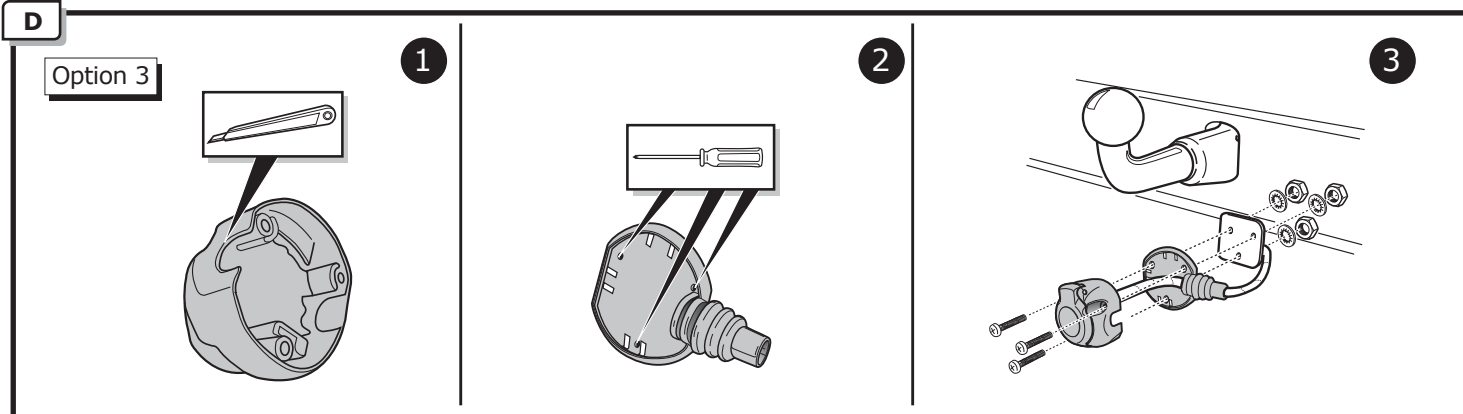
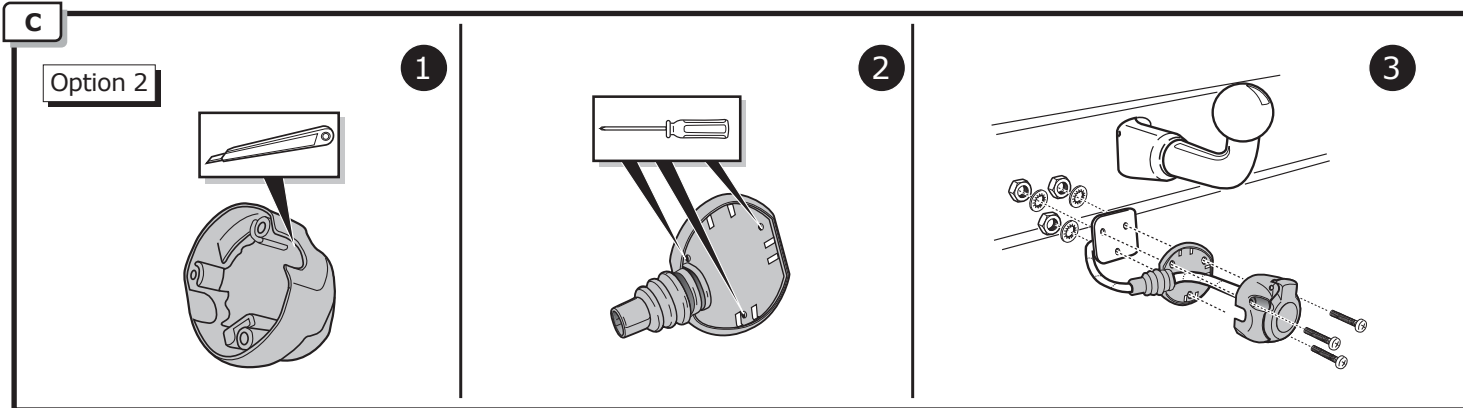
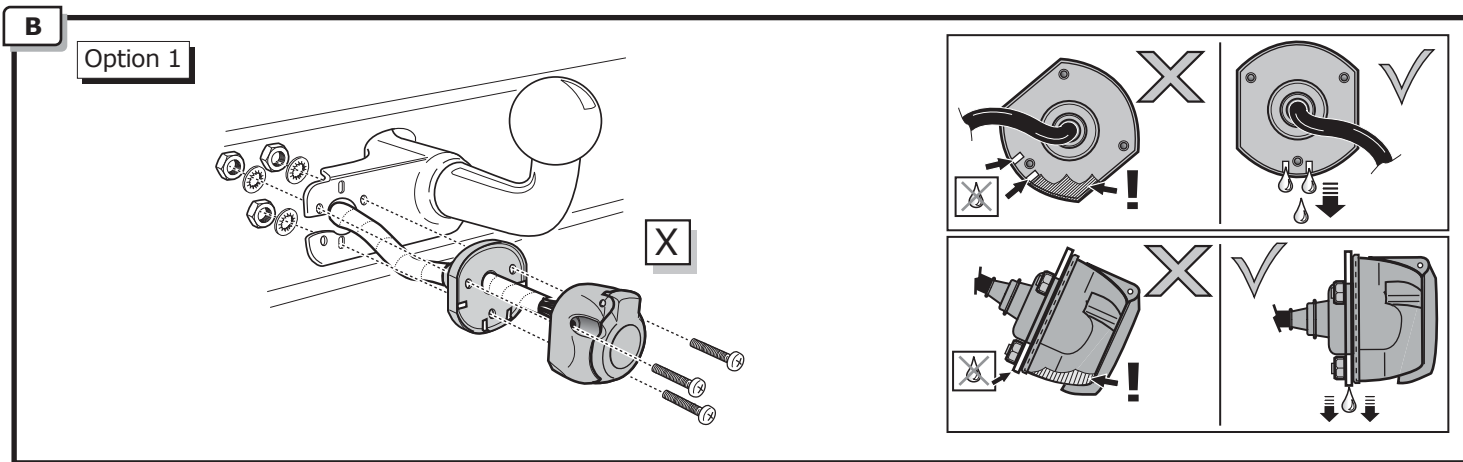

7

M1

M

1

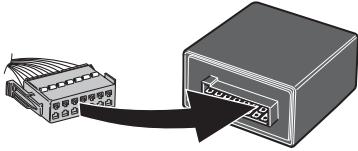

Important!
Please note informations
in picture 1!
Wichtig!
Unbedingt Hinweise
aus Bild 1 beachten!

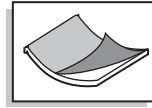

2

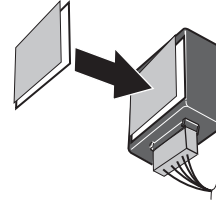
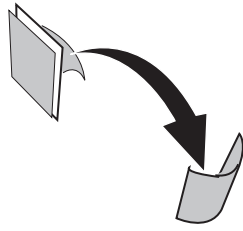

3

M

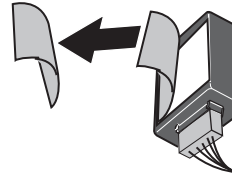

4

M

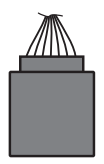
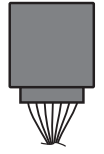

8

1

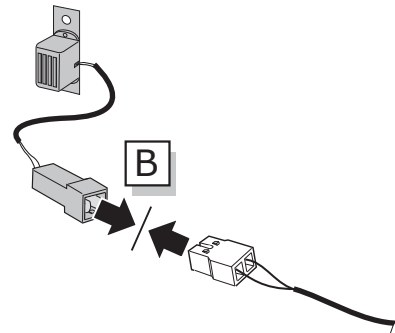

2

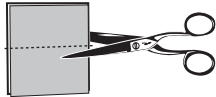
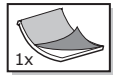

3

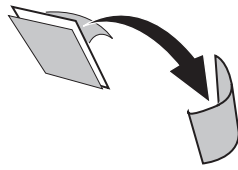

4

B

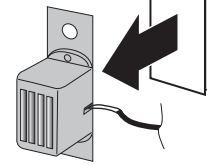

5

B

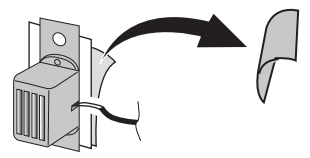

9

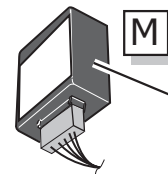
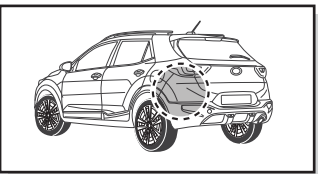

M

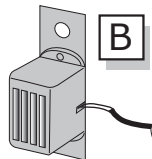

B

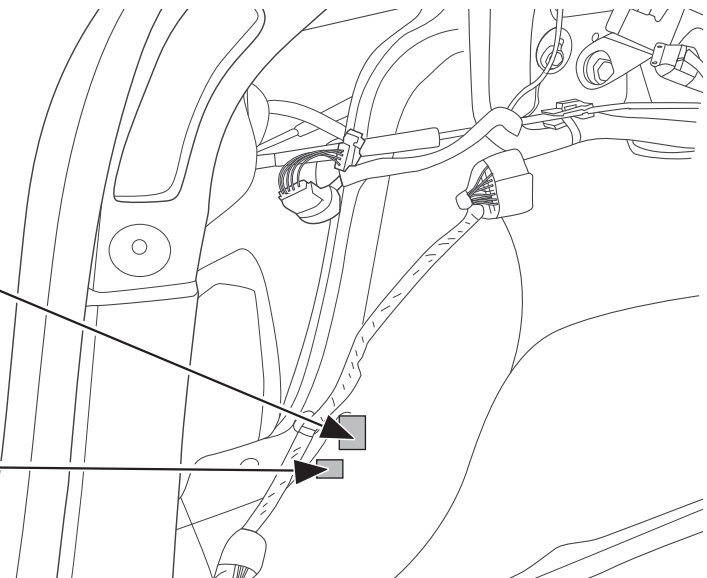

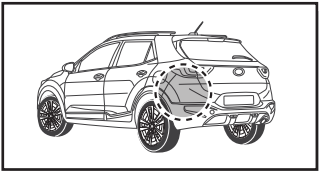

- | | |
|-----------------------------------|----------------------------|
| (DE) Klebeband entfernen. | (CZ) Odstraňte pásku. |
| (FR) Enlevez Ruban adhésif. | (DK) Aftag tapen. |
| (NL) Tape verwijderen. | (FI) Poista teippi. |
| (GB) Remove tape. | (GR) Αφαιρέστε την ταινία. |
| (ES) Retirar la cinta adhesiva. | (NO) Fjern limbåndet. |
| (IT) Rimuovere il nastro adesivo. | (PL) Zdjąć taśmę. |
| (SE) Avlägsna klisterbandet. | |

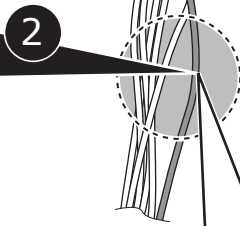
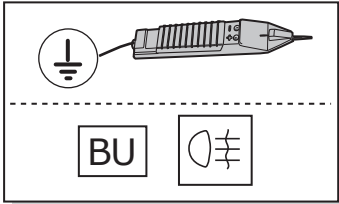
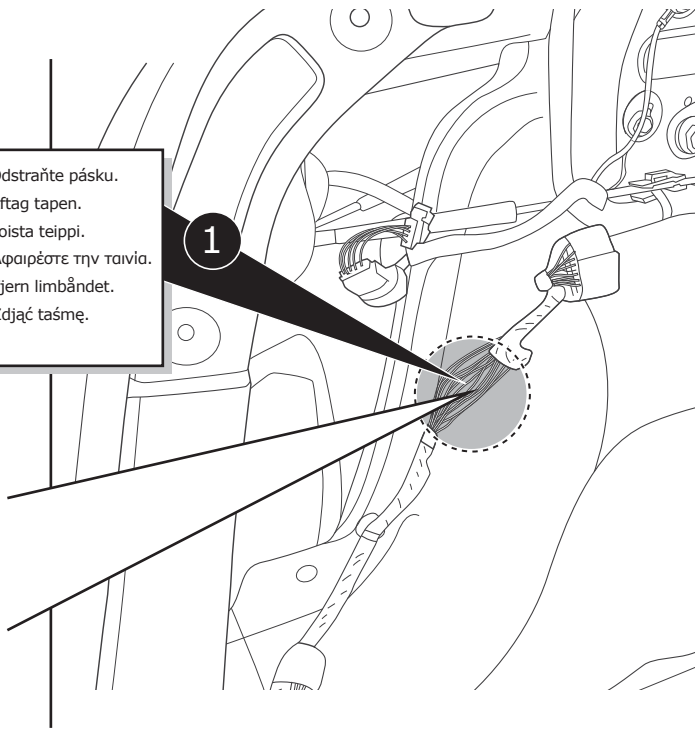

3

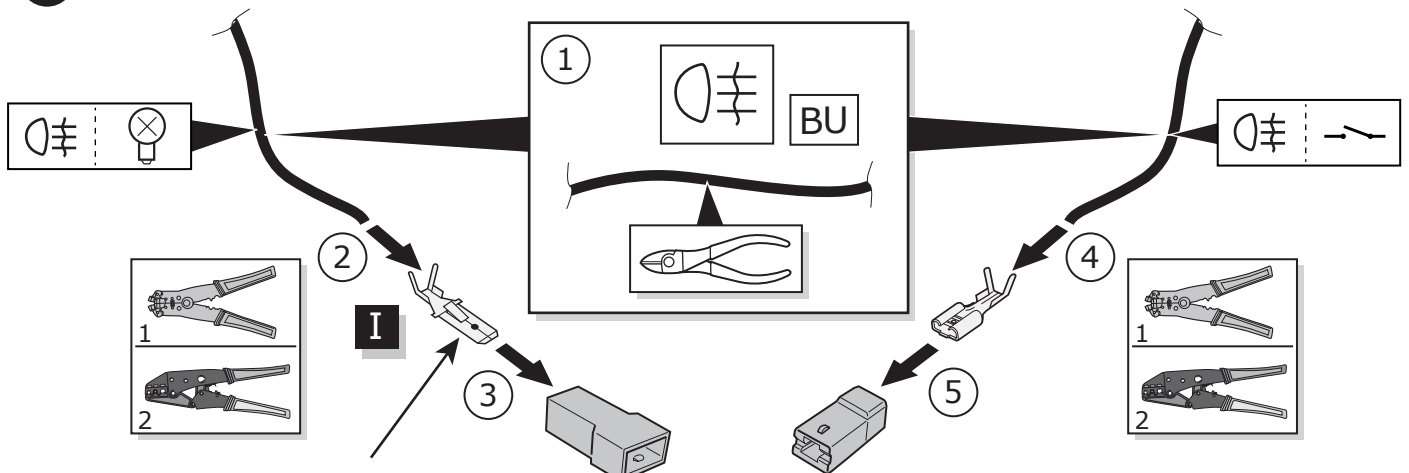

Use smaller contact!
Kleinere Kontakt verwenden!

4

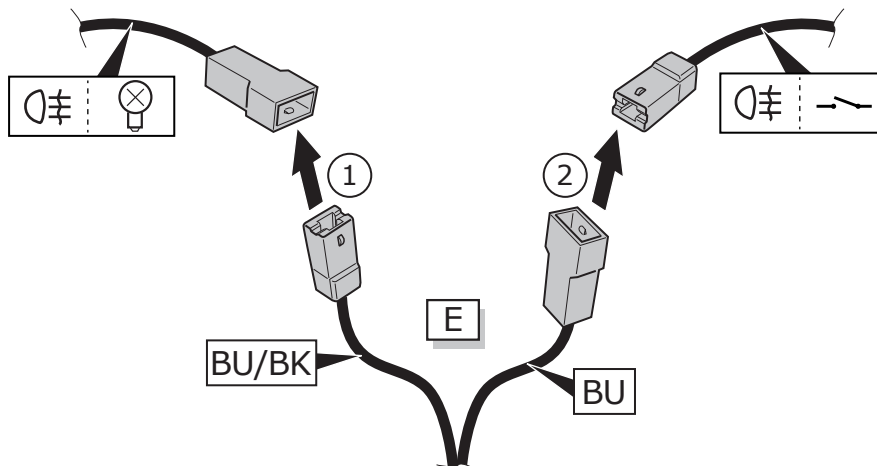

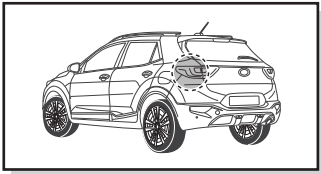

6-pole
WH

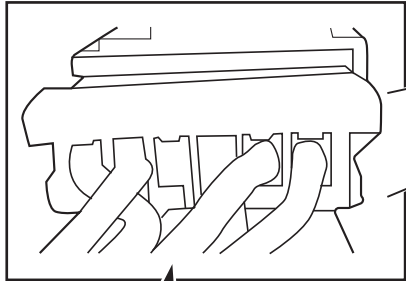

6-pole
WH

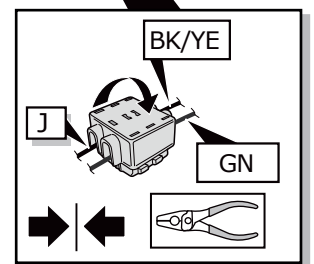
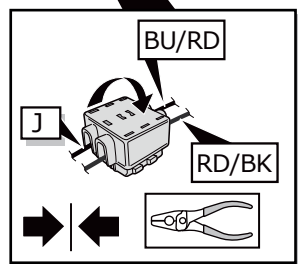
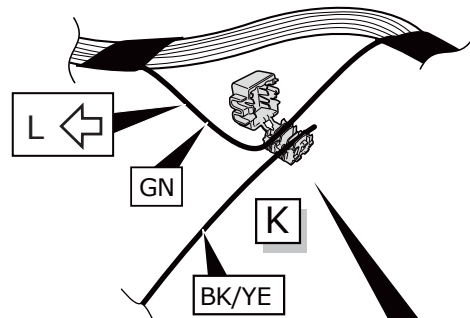
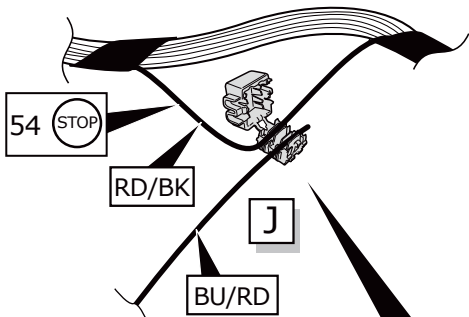
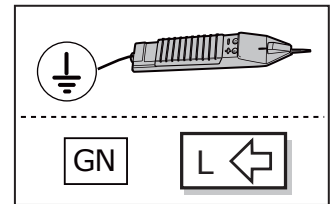
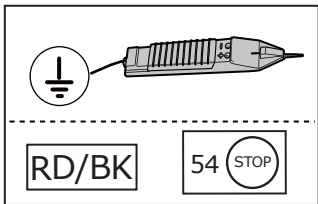
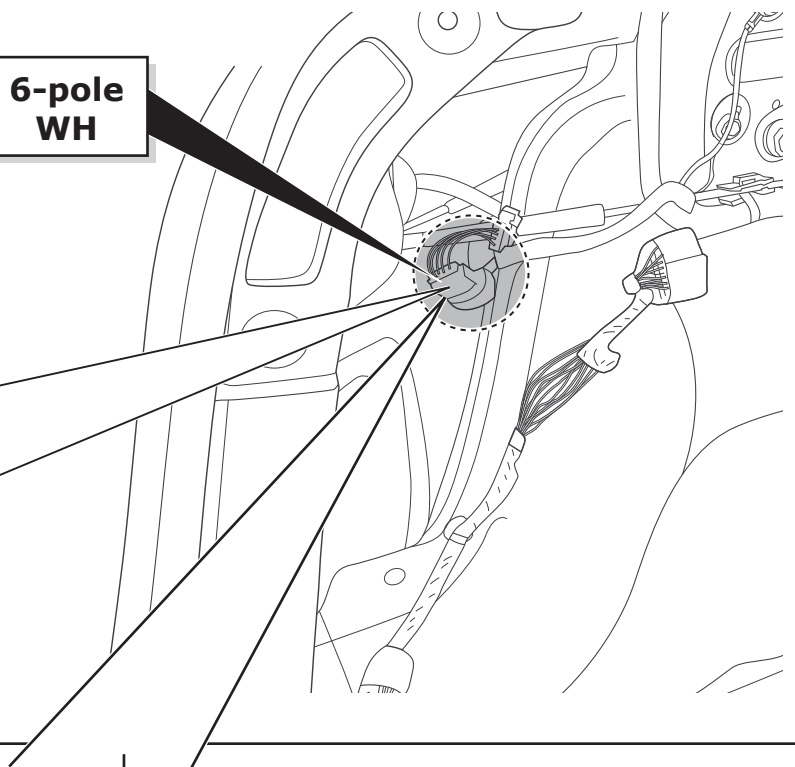

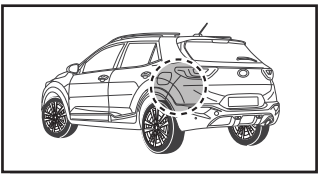
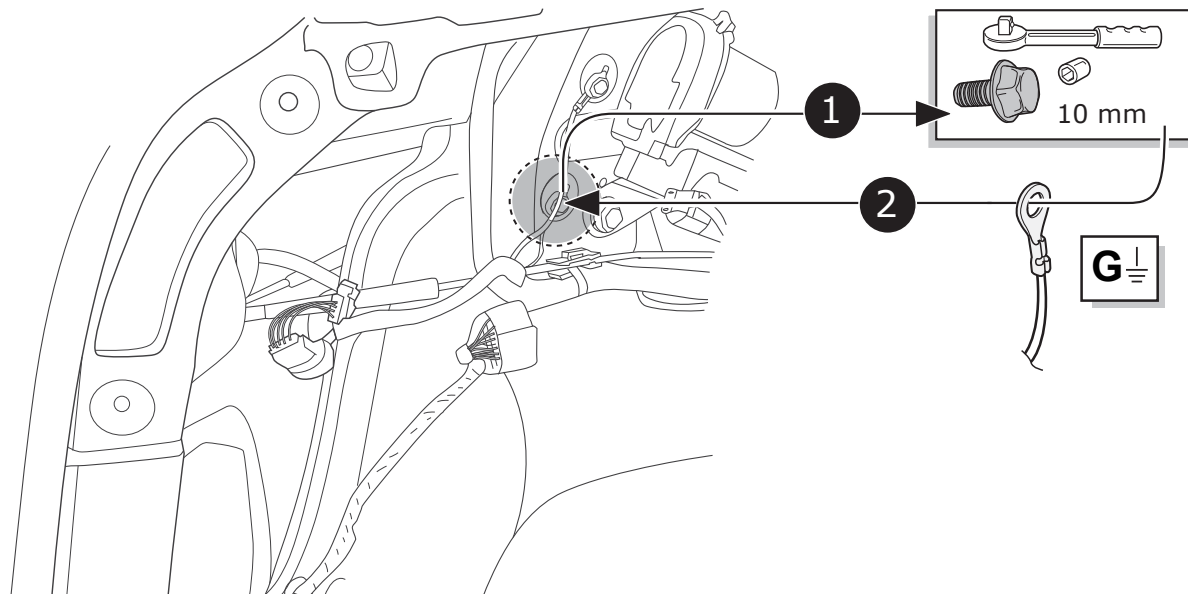
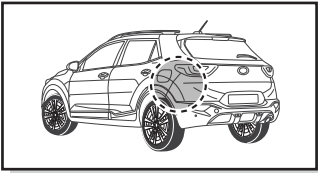

CAN-Adaption

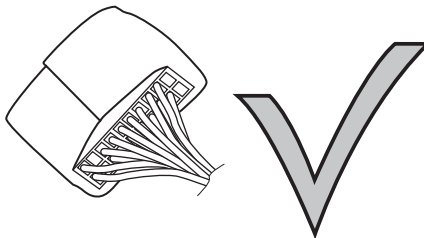

Option 1: 14-15

WH
20-PIN

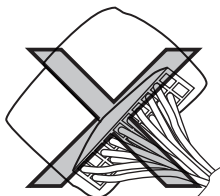
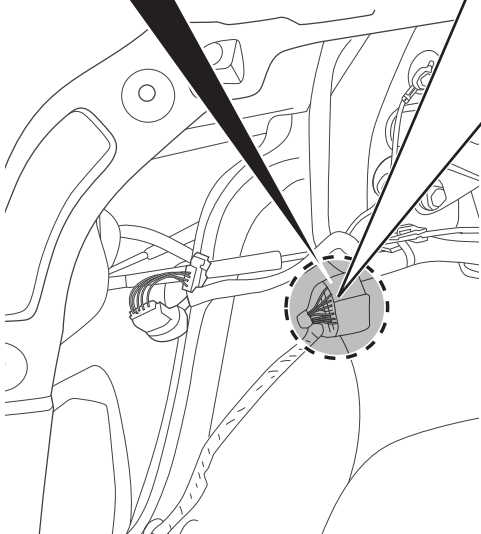

Option 2: 23-24

OBD - connector

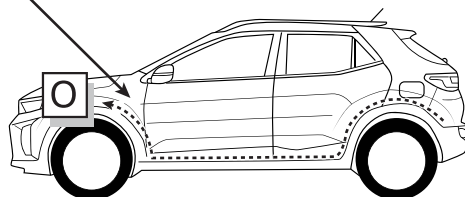

CAN-Adaption
Option 1:

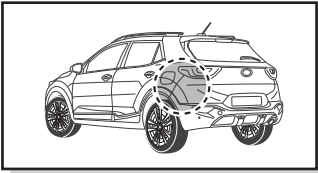
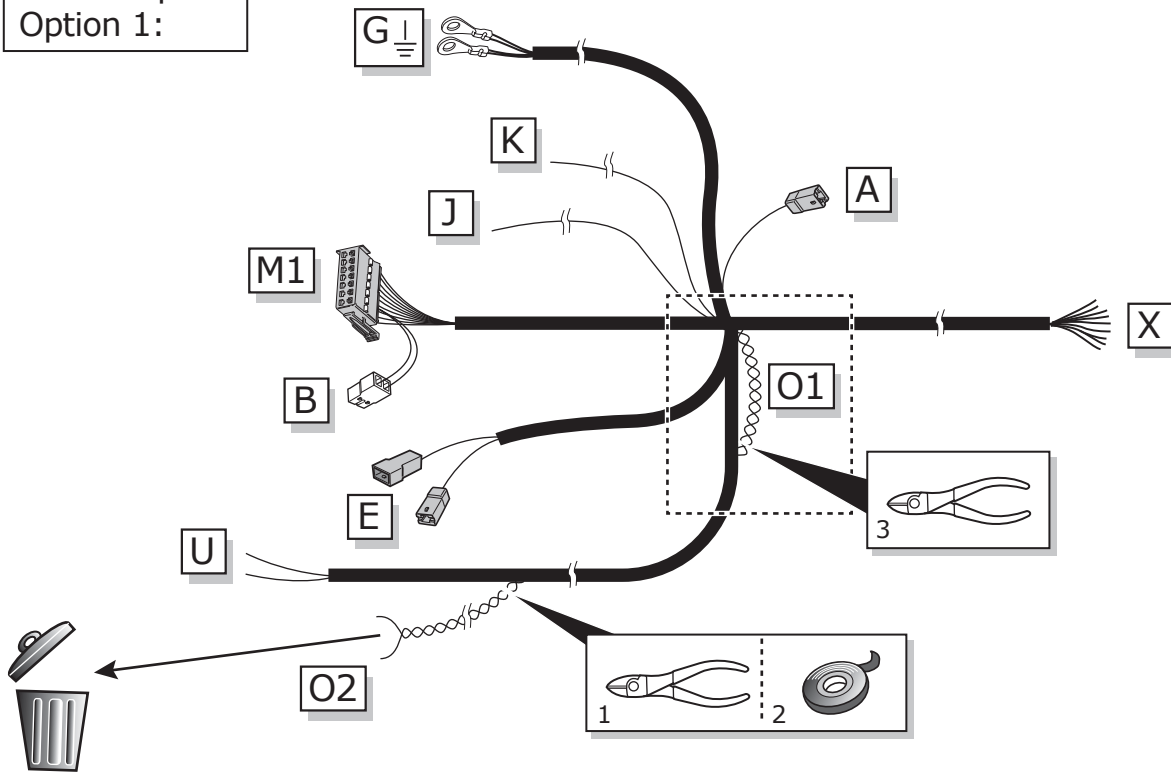

CAN-Adaption
Option 1:

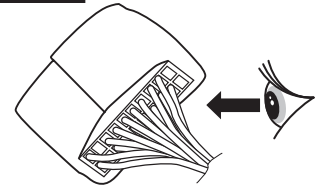
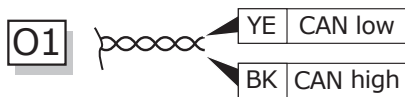
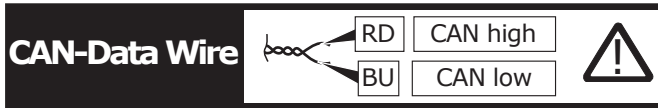

⚠ Important!
Please note informations
in picture 1!
Wichtig!
Unbedingt Hinweise
aus Bild 1 beachten!

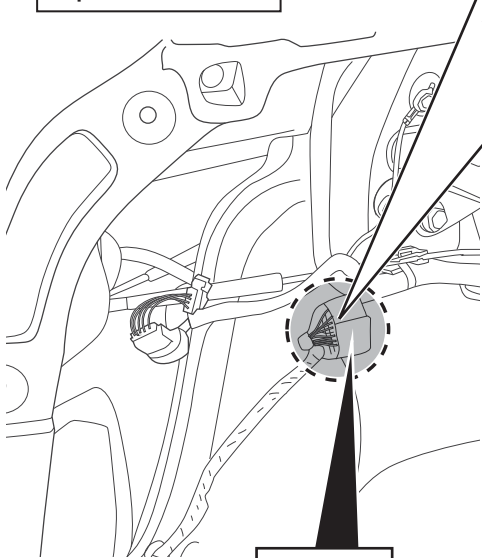

**WH
20-PIN**

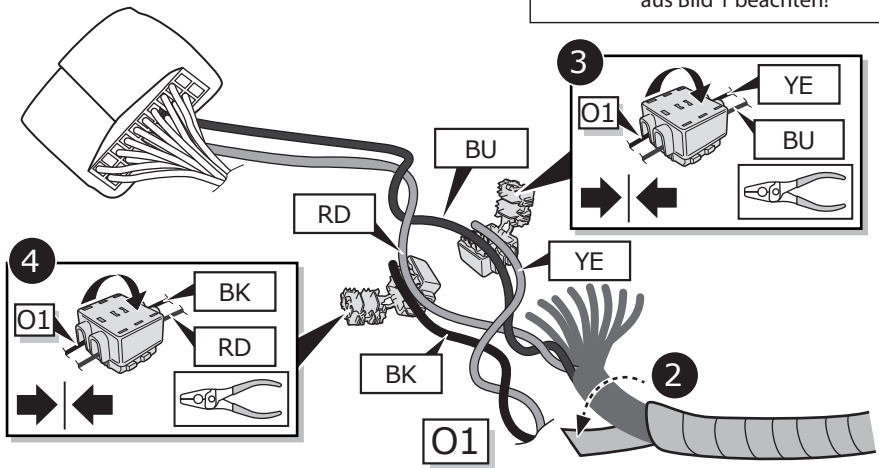

16

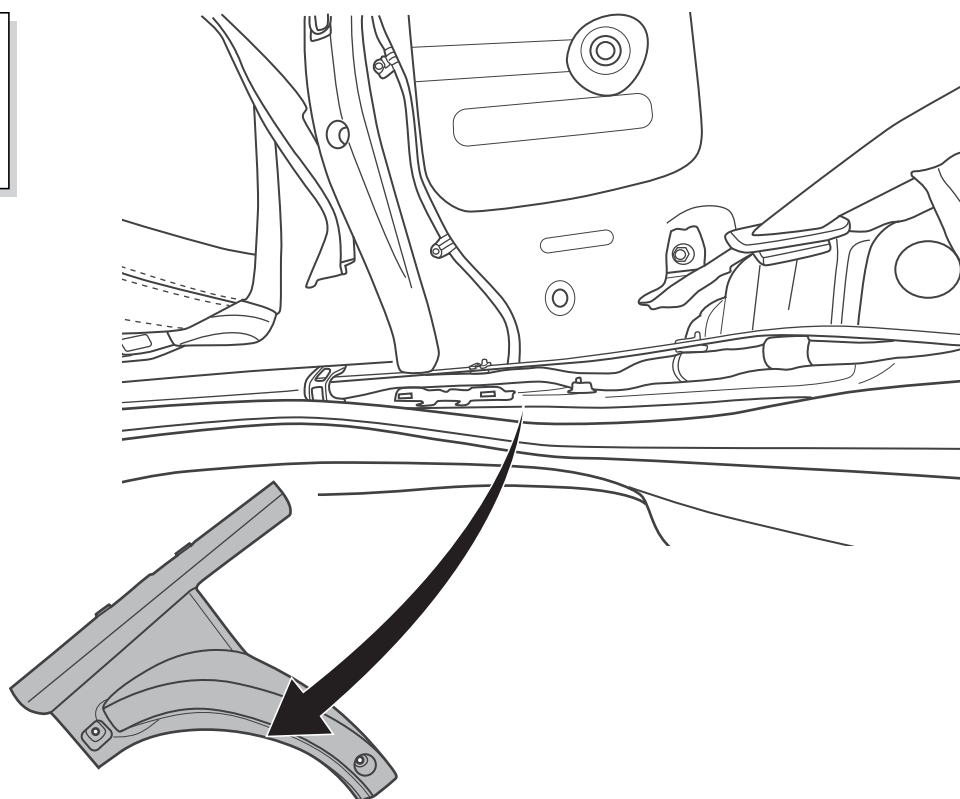
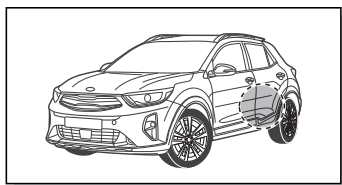

17

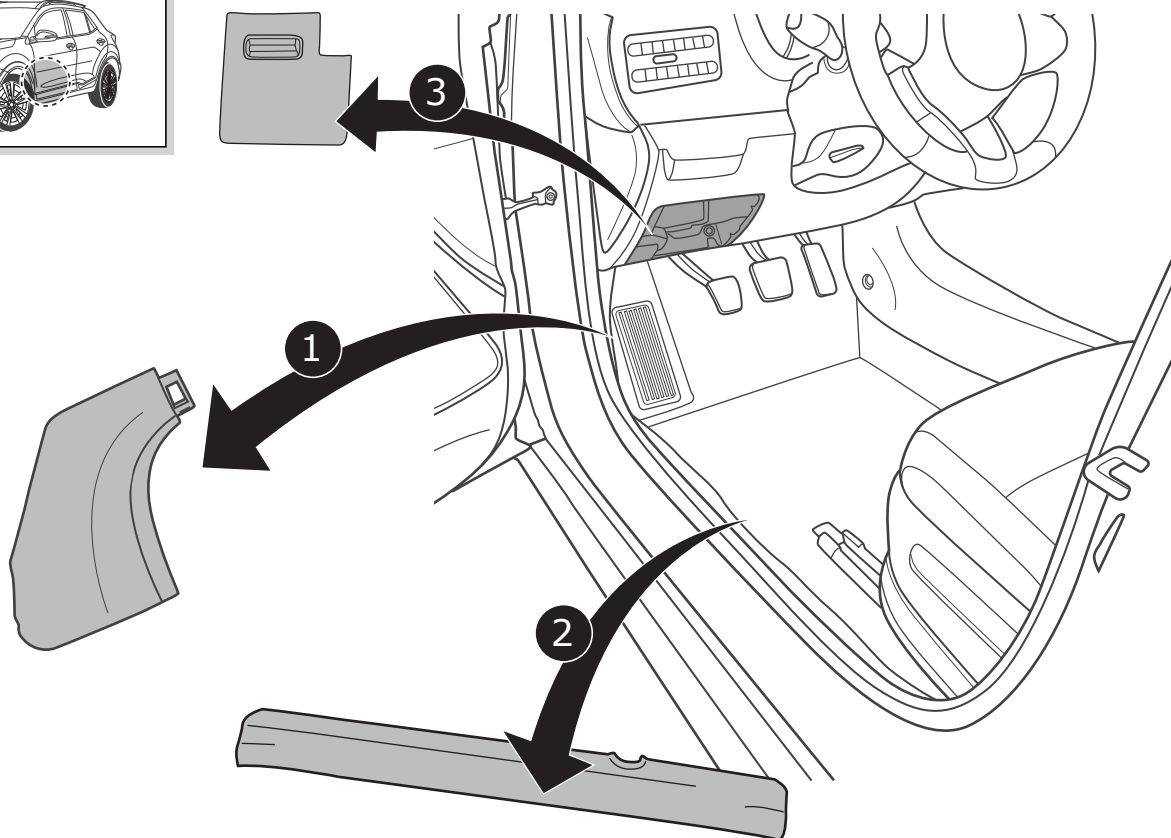
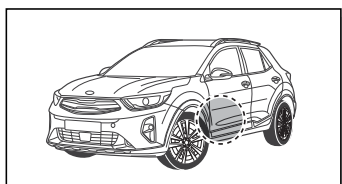

18

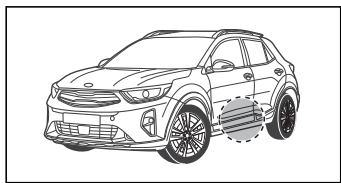

U

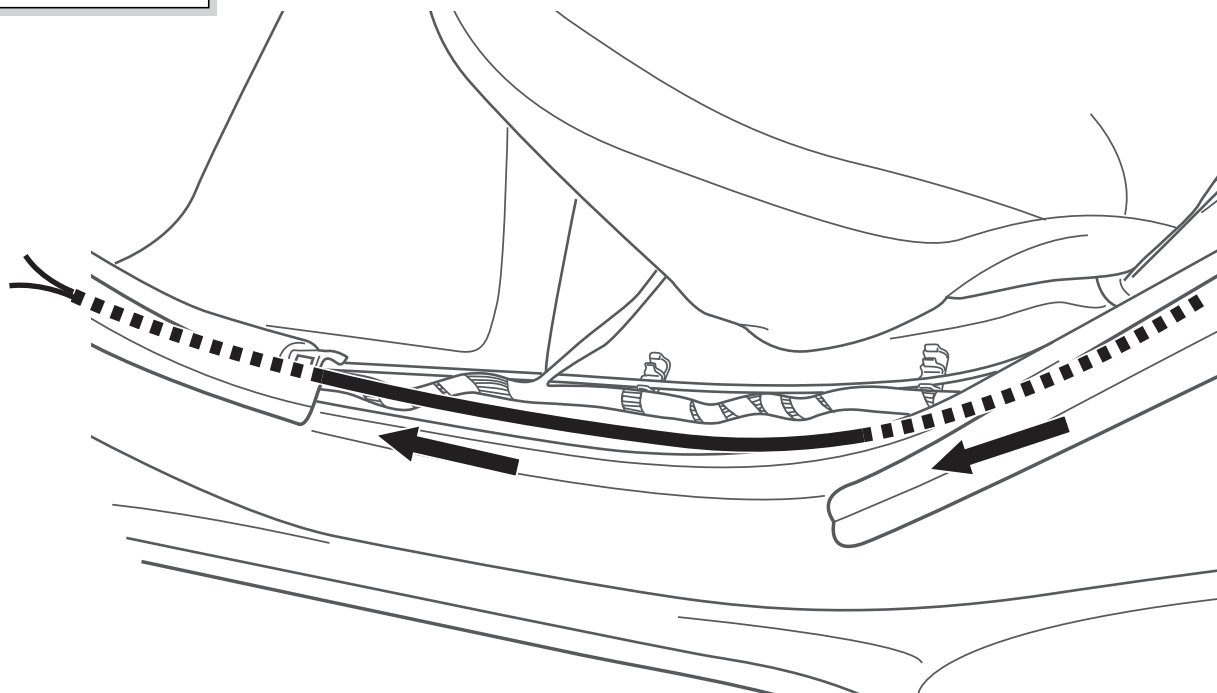

19

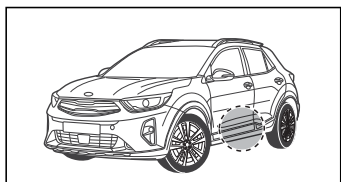

U

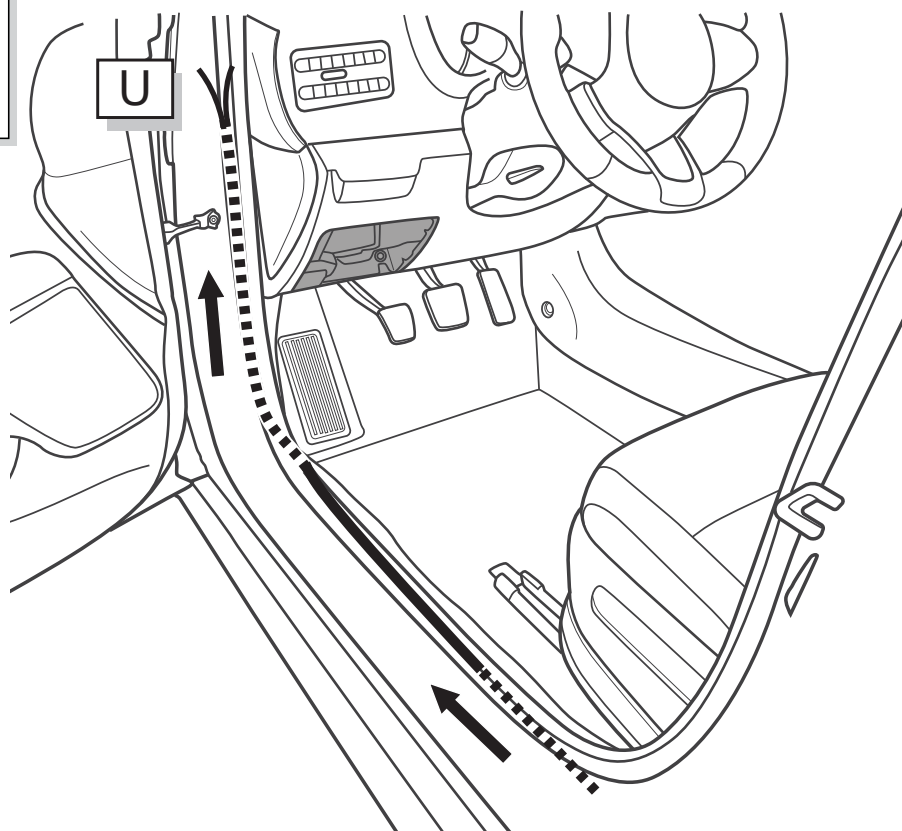

20

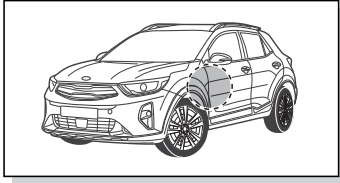

1

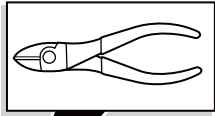

U

RD/BU
RD/BU

Cut to length!
Auf gewünschte
Länge zuschneiden!

2

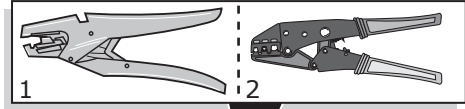

U

2x RD/BU

Z

Use bigger contact!
Grösseren Kontakt verwenden!

3

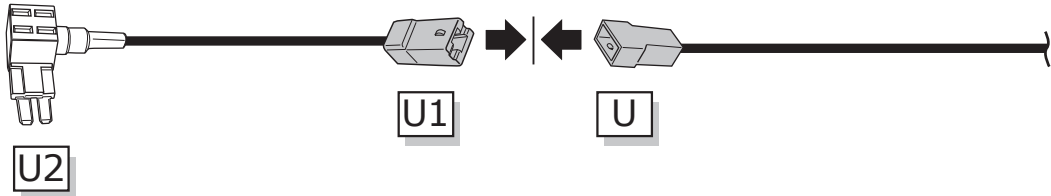

21

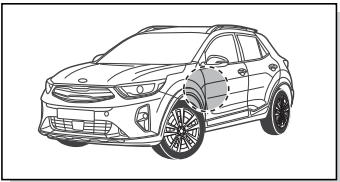

Option 1



SPARE 25A



25 Amp. 20 Amp.

U2

1

2

3

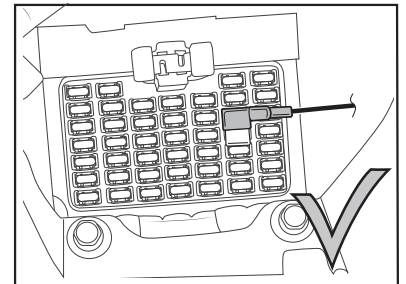
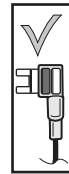

Wichtig!
Die Sicherungsbrücke
darf nicht in
entgegengesetzter
Richtung eingebaut
werden!

Important!
Please do not mount
the fuse tap and its
wiring output in
the other
direction!

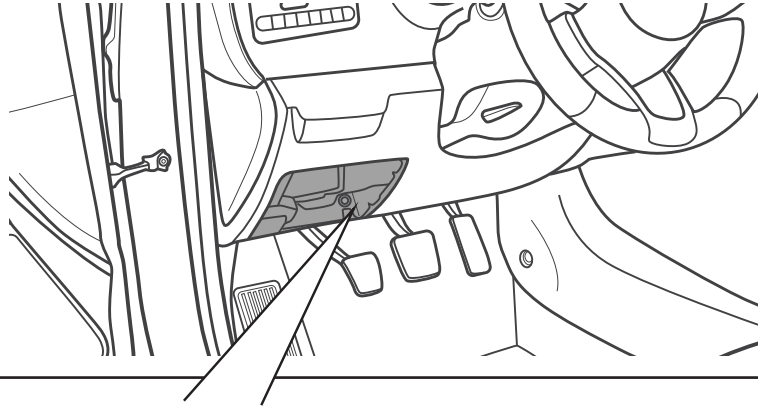
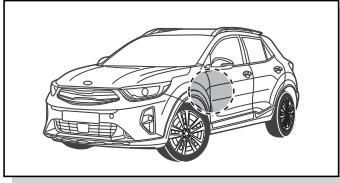

Option 2

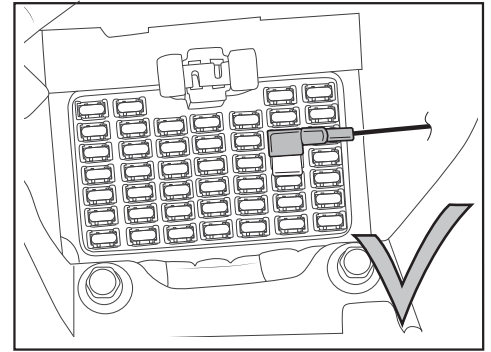
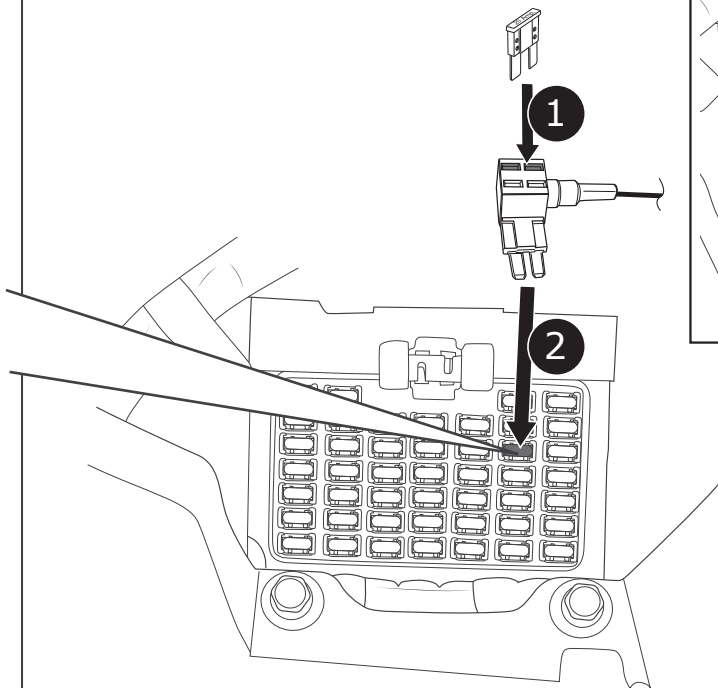

Wichtig!
Die Sicherungsbrücke darf nicht in entgegengesetzter Richtung eingebaut werden!

Important!
Please do not mount the fuse tap and its wiring output in the other direction!

CAN-Adaption Option 2:

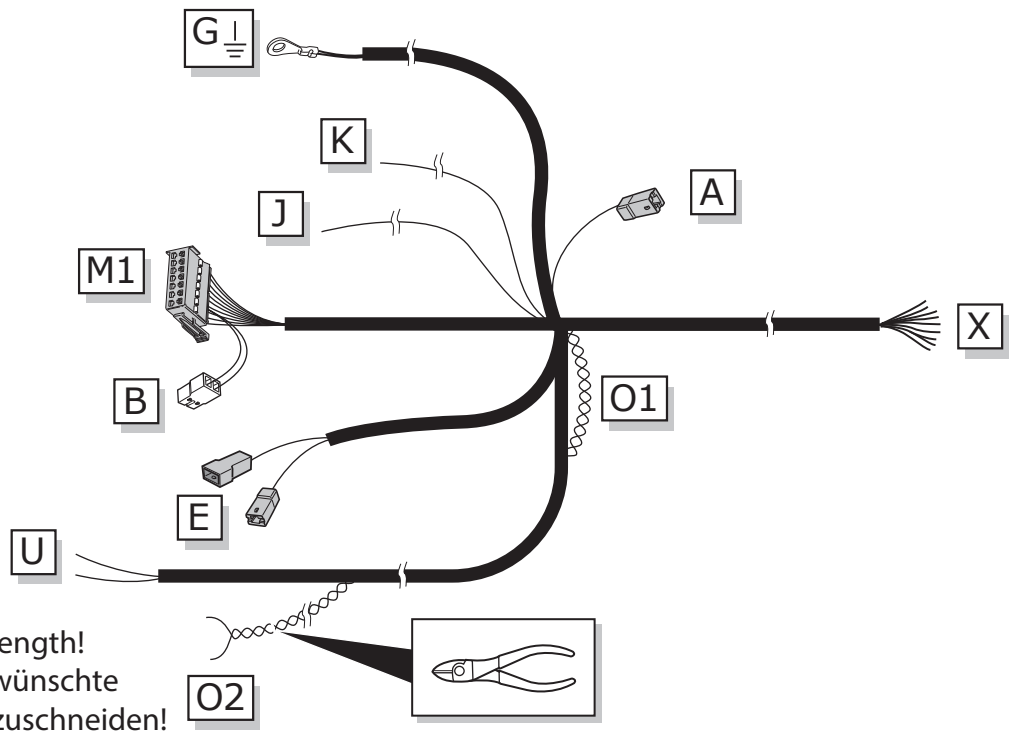

Cut to length!
Auf gewünschte Länge zuschneiden!

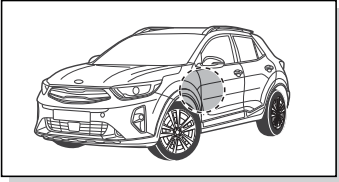

CAN-Adaption
Option 2:

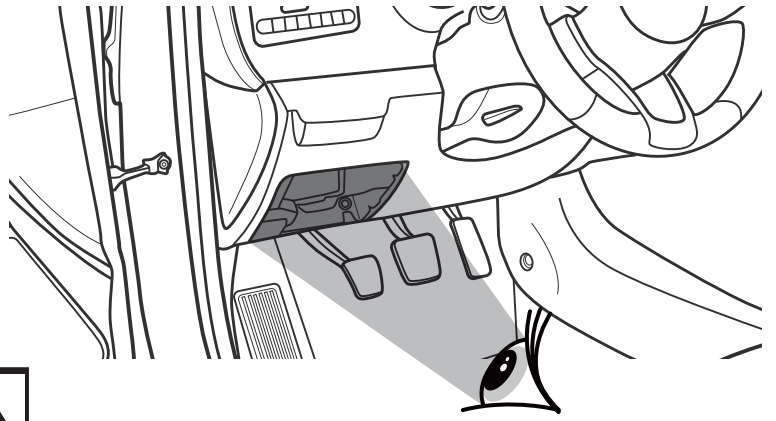

CAN-Data Wire

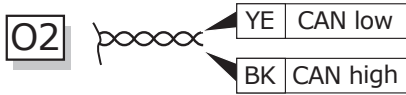
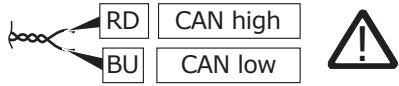

OBD - connector

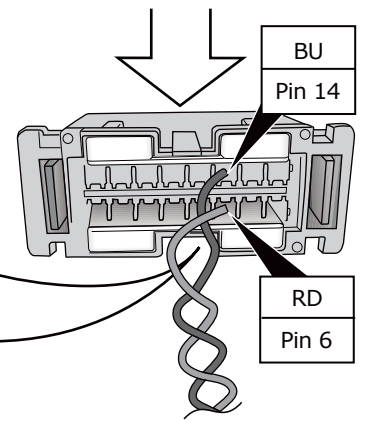
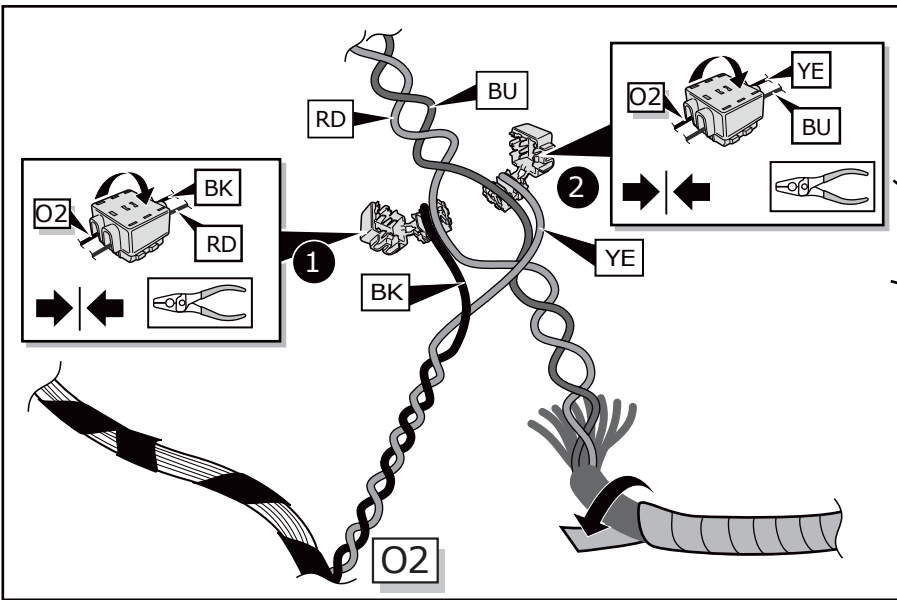

! Important!
Please note informations
in picture 1!
Wichtig!
Unbedingt Hinweise
aus Bild 1 beachten!

Optional

! MAX = 21W

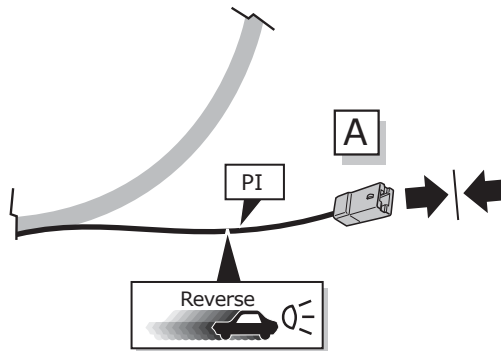

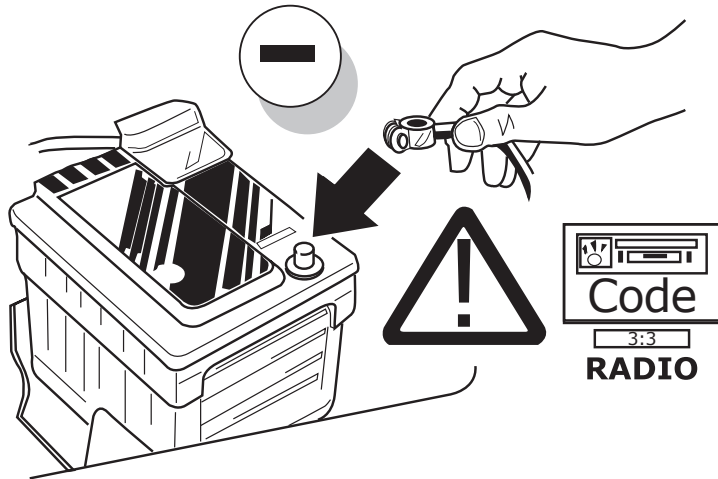

Functional test

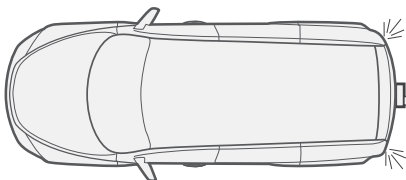
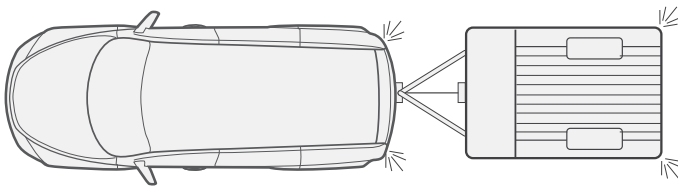
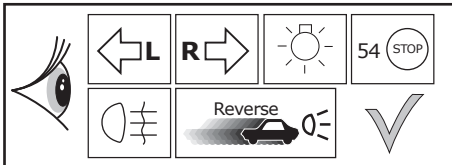

LIGHTMATE

ECS part no.
LIGHTMATE II
LIGHTMATE III

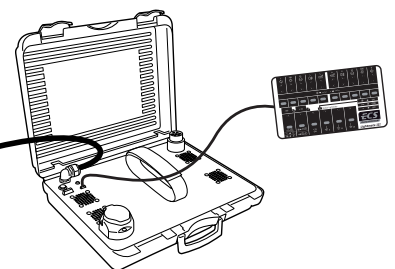

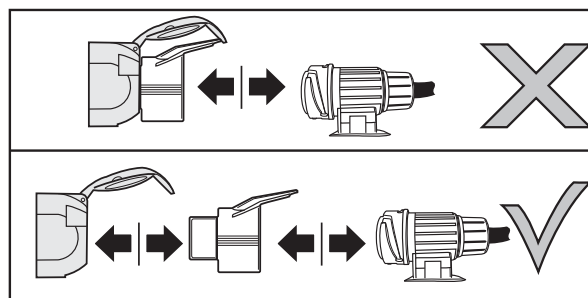
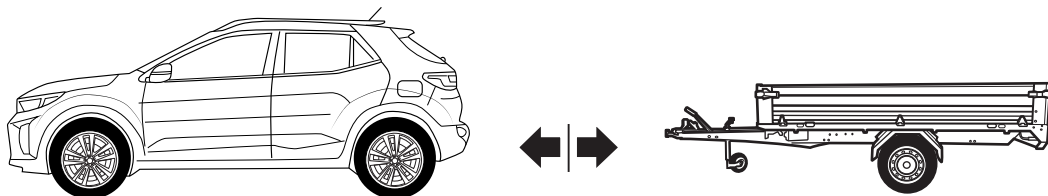
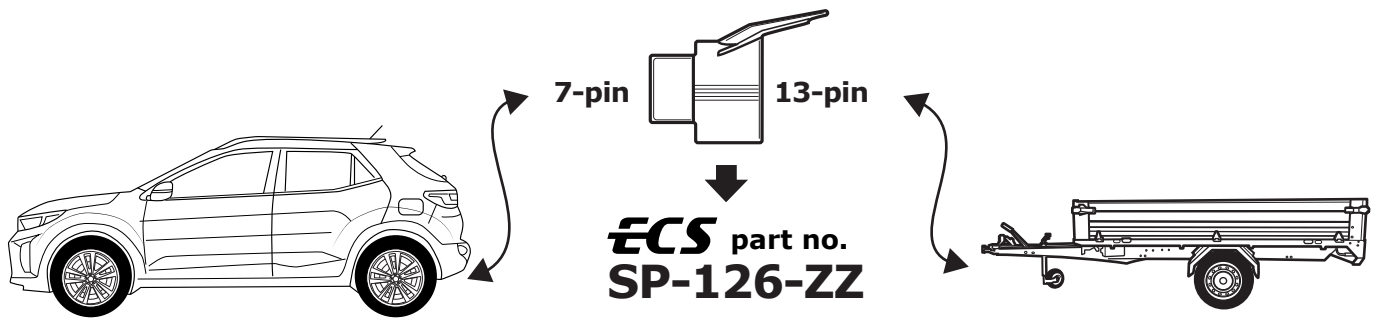
Optional**Adapter socket**

- ⓁⒹ Einzelteile wieder einbauen
- ⓁⒹ Remonter les pièces démontées
- ⓁⒹ Terug plaatsen onderdelen
- ⓁⒹ Reinstall linings
- ⓁⒹ Reinstalar componentes
- ⓁⒹ Rimetti a posto componenti

Products & Service: <https://www.ecs-electronics.nl/test-equipment>

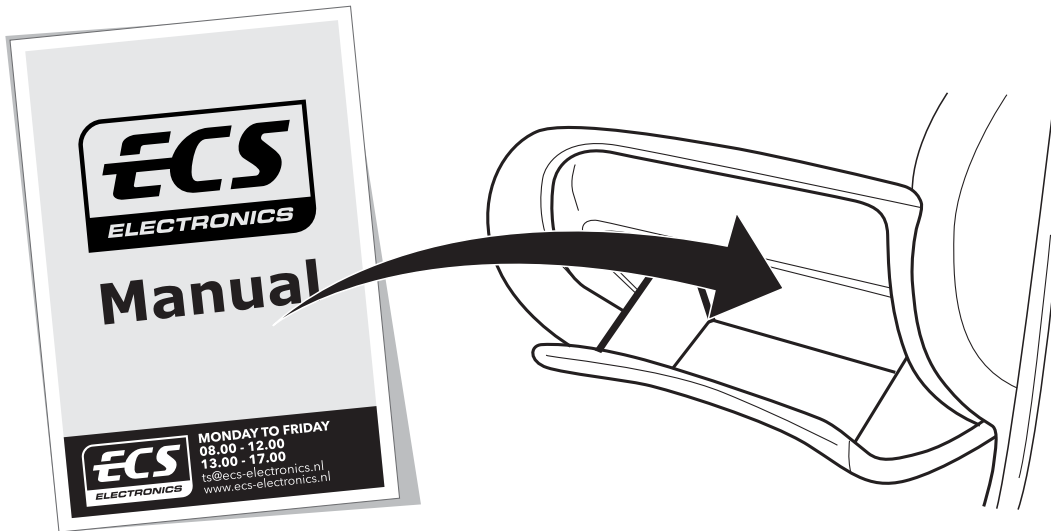
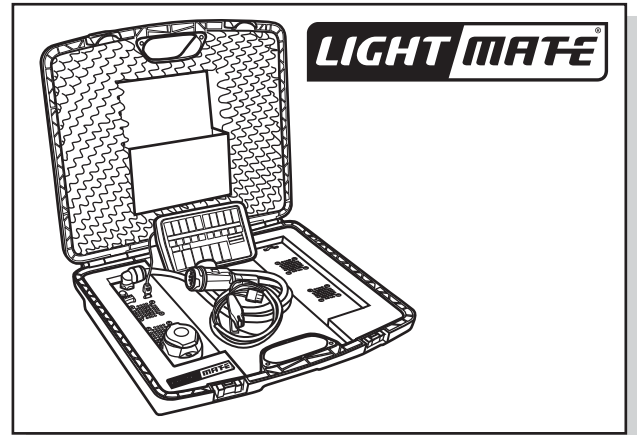
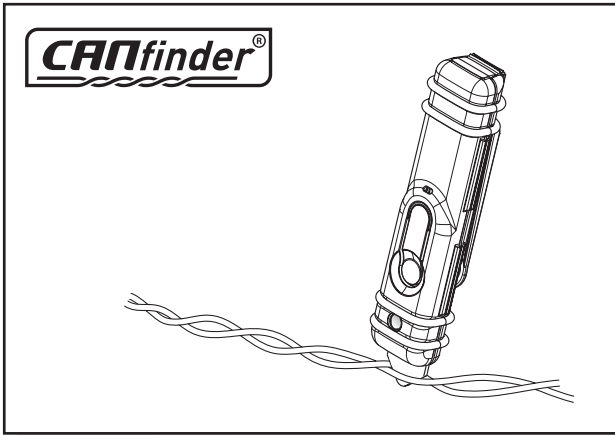

**FITTERS
TECHNICAL
SUPPORT**



**MONDAY TO FRIDAY
08.00 - 12.00
13.00 - 17.00**

ts@ecs-electronics.nl
www.ecs-electronics.nl
tel: +31 (0)76 573 0020

INFO

- (DE) Anschluss Steckdose (ES) Conexión de la caja de enchufe (CZ) Objímkový konektor (GR) Υποδοχή σύνδεσης
- (FR) Connection de la prise (IT) Allaccio zoccolo (DK) Stikdåse forbindelse (NO) Tilkobling koblingsboks
- (NL) Contactdoos aansluiting (SE) Anslutning kontaktdosa (FI) Pistorasia liitäntä (PL) Połączenie przez gniazdo
- (GB) Socket connection

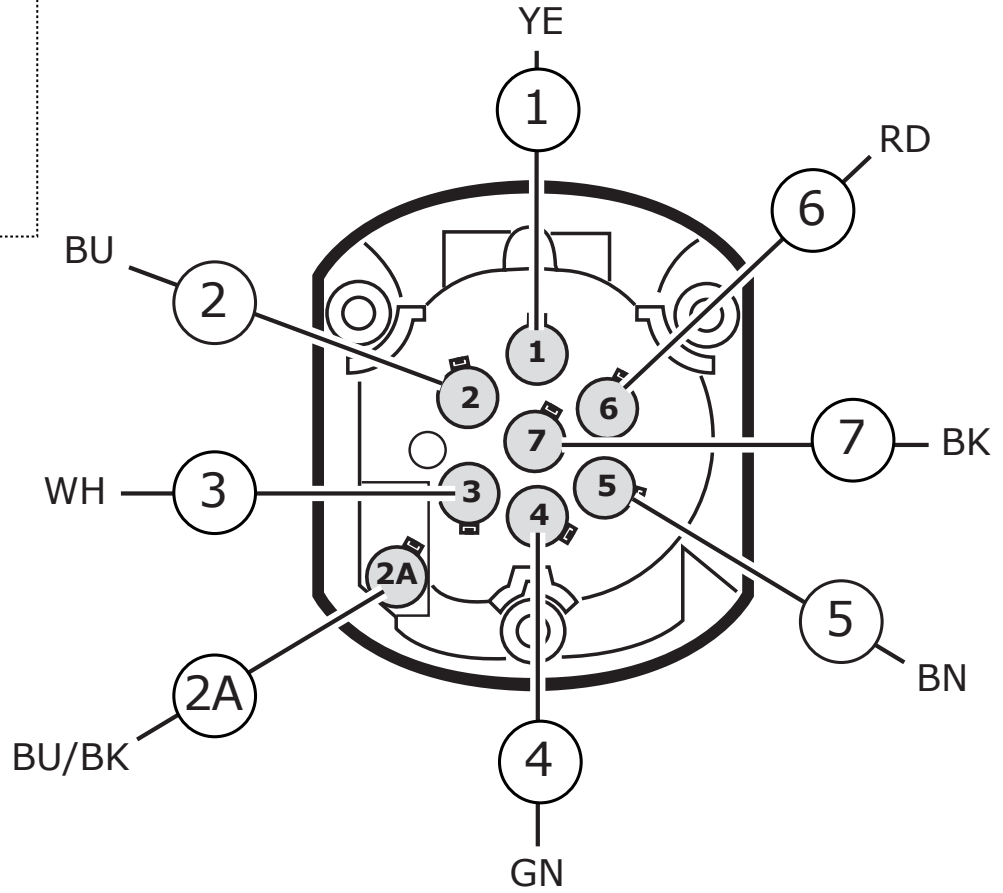
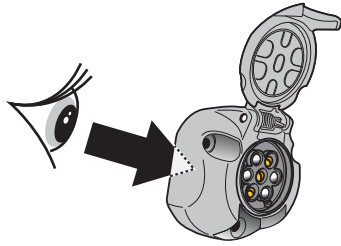

- (DE) Anschluss Steckdose (ES) Conexión de la caja de enchufe (CZ) Objímkový konektor (GR) Υποδοχή σύνδεσης
- (FR) Connection de la prise (IT) Allaccio zoccolo (DK) Stikdåse forbindelse (NO) Tilkobling koblingsboks
- (NL) Contactdoos aansluiting (SE) Anslutning kontaktdosa (FI) Pistorasia liitäntä (PL) Połączenie przez gniazdo
- (GB) Socket connection

DIN/ISO 1724								
Pmax	21W	21W			21W	42W	3x21W	42W
	YE	BU	BU/BK	WH	GN	BN	RD	BK

COLORTABLE

	BK	BN	BU	GY	GN	WH	YE	OG	PE	PI	RD
(DE)	Schwarz	Braun	Blau	Grau	Grün	Weiß	Gelb	Orange	Violett	Rosa	Rot
(FR)	Noir	Marron	Blue	Gris	Vert	Blanc	Jaune	Orange	Violet	Rose	Rouge
(NL)	Zwart	Bruin	Blauw	Grijs	Groen	Wit	Geel	Oranje	Paars	Roze	Rood
(GB)	Black	Brown	Blue	Grey	Green	White	Yellow	Orange	Purple	Pink	Red
(ES)	Negro	Marrón	Azul	Gris	Verde	Bianco	Amarillo	Naranja	Morado	Rosa	Rojo
(IT)	Nero	Marrone	Blu	Grigio	Verde	Bianco	Giallo	Arancione	Viola	Rosa	Rosso
(SE)	Svart	Brun	Blå	Grå	Grön	Vit	Gul	Orange	Lila	Rosa	Röd
(CZ)	Černá	Hnědá	Modrá	Šedá	Zelená	Bílá	Žlutá	Oranžová	Fialová	Růžová	Červená
(DK)	Sort	Brun	Blå	Grå	Grøn	Hvid	Gul	Orange	Lilla	Pink	Rød
(FI)	Musta	Ruskea	Sininen	Harmaa	Vihreä	Valkoinen	Keltainen	Oranssi	Purppura	Vaaleanpunainen	Punainen
(GR)	Μαύρο	Καφέ	Μπλε	Γκρι	Πράσινο	Λευκό	Κίτρινο	Πορτοκαλί	Μοβ	Ροζ	Κόκκινο
(NO)	Svart	Brun	Blå	Grå	Grønn	Hvit	Gul	Oransje	Lilla	Rosa	Rød
(PL)	Czarny	Brazowy	Niebieski	Szary	Zielony	Biały	Żółty	Pomarańczowy	Purpurowy	Różowy	Czerwony